

Barrier

MHTM™ MicroDrive

Control unit MGC und MGC-Pro

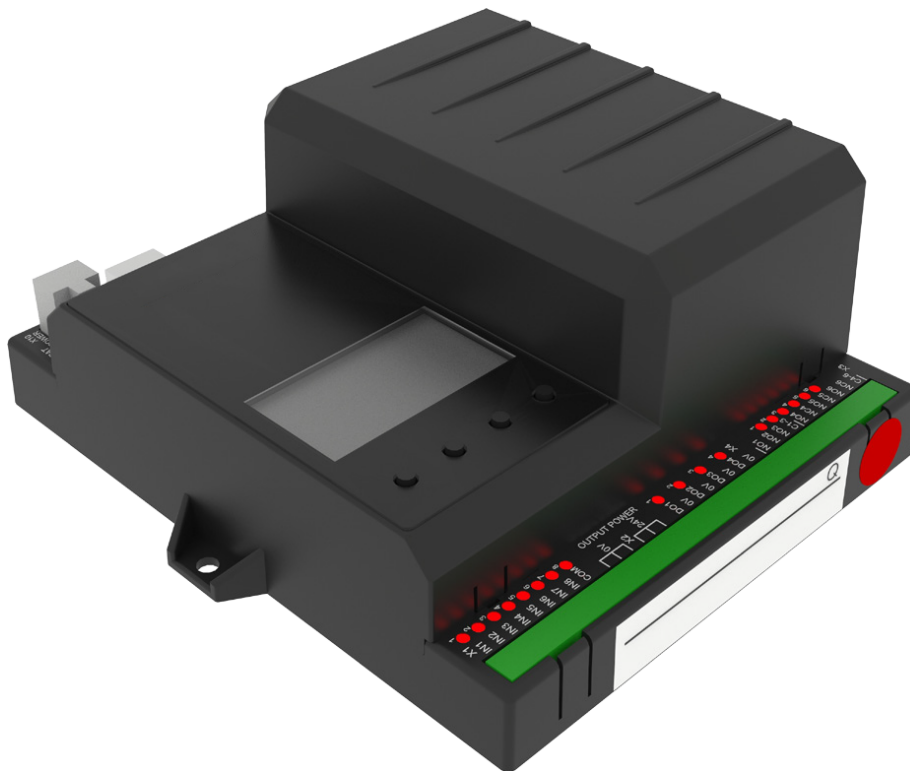

Doc.ID: 5816,0006US

Version: 04

Contents

1	General	5
1.1	Information on the instructions.....	5
1.2	Pictogram explanation	5
1.3	Requirements to the specialists.....	6
2	Digital inputs, digital outputs and output relays	7
2.1	Overview: Barrier types, control unit types, freely parameterisable or firmly assigned input and output functions	7
2.2	Digital inputs	8
2.3	Digital outputs and output relays	12
3	Parameterizing control unit	20
3.1	Safety.....	20
3.2	Changing menu language.....	20
3.3	Entering password	23
3.4	Control elements control unit.....	25
3.5	Displays on the control unit.....	25
3.6	Symbols in the display	27
3.6.1	Control button functions	27
3.6.2	Current state of the barrier	28
3.6.3	Current program mode	30
3.6.4	Current state of the induction loops	30
3.6.5	Further symbols.....	30
3.7	Setting display contrast.....	31
3.8	Protecting parameterization from access	31
3.9	Parameterizing options	32
3.10	Parameterizing values	33
3.11	Overview program mode	34
3.11.1	Program modes for vertical barriers "Access", "Parking" and "Toll"	34
3.11.2	Program modes for horizontal barriers "Traffic H"	35
3.11.3	Mode 1: Maintained contact	36
3.11.4	Mode 2: Deadman	36
3.11.5	Mode 3: Pulse control (bistable).....	37
3.11.6	Mode 4: Two-pulse control (Open/Closed button).....	38
3.11.7	Automatic Modes 5 to 8: Drive directions 1 – overview and differences.....	39
3.11.8	Automatic Modes 5 to 8: Drive direction 2 ...	43
3.11.9	Mode "Service "	44
3.12	Menu "Information" (i).....	45

Contents

3.13	Menu "Function"	46
3.13.1	Prog. mode (Program mode).....	46
3.13.2	Close direction	46
3.14	Menu "Setup"	47
3.14.1	Barrier speed	47
3.14.2	Delays	47
3.14.3	Cut off angle	49
3.14.4	Vend count.....	50
3.14.5	Impact settings.....	53
3.14.6	Start-up settings.....	55
3.14.7	Start-up behav. (Start-up behaviour).....	56
3.14.8	Power failure	61
3.15	Menu "In-/Outputs".....	62
3.15.1	Inputs	62
3.15.2	Outputs	62
3.15.3	Inverted In-/Outputs	62
3.16	Menu "Special functions"	63
3.16.1	Closure by light barrier	63
3.16.2	Closure by add. safety	64
3.16.3	Stop at tailgating	64
3.16.4	Master/Slave	65
3.17	Menu "Attachments".....	66
3.17.1	Signal light	66
3.17.2	Boom contact settings	69
3.17.3	Locking	71
3.17.4	Battery backup.....	72
3.18	Menu "Service".....	73
3.19	Menu "System".....	74
3.20	Menu "Information".....	74
3.21	Menu "Motor GW (Gateway).....	75
3.22	Menu "Detector 1 (A-B)".....	75
3.22.1	Check the working frequency of the induction loops.....	78
3.22.2	Reconciling and setting the operating frequency of the induction loop.....	78
3.23	Menu "Detector 2 (C-D)"	81
3.24	Menu "Radio control FM"	81
3.25	Factory settings.....	84
4	Menu setup	87
	Index.....	93

1 General

1.1 Information on the instructions

These instructions describe the control unit MGC and the associated plug-in modules from the program versions named below onwards. Software number (software #) and software version (SW version) are displayed in the menu "Module info".

For information about assembly, electrical connection, troubleshooting and maintenance, see the corresponding operating instructions.

Program versions Control unit MGC and plug-in modules

Designation	Software #	SW version
Master Controller Standard	4915,1000	1.1
Motor Gateway Controller	4915,3000	0.13
Detector module 2-channel	4915,3001	0.14
Radio module 433 MHz	4915,3003	0.12

Table 1: Program versions

1.2 Pictogram explanation

Warning notes

Warning notes are characterized by pictograms in these operating instructions. The warning notes are followed by signal words expressing the scale of the hazard.

It is absolutely essential to observe the notes and to proceed with caution in order to prevent accidents as well as bodily injuries and property damage.

⚠ WARNING	
	The signal word WARNING points to a potentially dangerous situation, which can lead to death or severe injuries if it is not avoided.

Hints and recommendations





NOTE!

...highlights useful hints and recommendations as well as information for an efficient and trouble-free operation.

General

1.3 Requirements to the specialists

 WARNING	
	<p>Risk of injury in case of inadequate qualification!</p> <p>Improper handling can lead to considerable bodily injuries and property damage.</p> <ul style="list-style-type: none">– Have any activities only carried out by the individuals designated for that purpose.

MHTM™ MicroDrive service experts

are able, due to their technical training, knowledge and experiences as well as knowledge of the relevant standards and regulations, to execute tasks on electrical systems and to independently recognize possible hazards.

Additionally, these electricians are trained and authorized to perform special repair and service work at MHTM™ MicroDrive barriers.

In Germany, the electrical specialist must comply with the provisions of accident prevention regulation BGV A3 (e.g. master electrical fitter). Appropriate regulations apply in other countries. The regulations valid there must be observed.

Digital inputs, digital outputs and output relays**2 Digital inputs, digital outputs and output relays****2.1 Overview: Barrier types, control unit types, freely parameterisable or firmly assigned input and output functions**

For barriers with an MGC-Pro control unit, the functions of the digital inputs and outputs can be parameterized freely.

For barriers with an MGC control unit, the functions of the inputs are firmly assigned.

Additionally, individual inputs and outputs can be deactivated in barriers with an MGC-Pro control unit. Furthermore, the service can invert individual inputs and outputs and therefore the assigned functions, in these barriers.

→ For input and output parameterization, refer to chapter 3, from page 20.

Barrier type	Control unit	Inputs and outputs	
		Freely parameterisable	Firmly assigned
Access	MGC	–	Yes
Access-L	MGC	–	Yes
Access Pro	MGC-Pro	Yes	–
Access Pro L	MGC-Pro	Yes	–
Access Pro H	MGC-Pro	Yes	–
Access XL / XL2 / XXL	MGC-Pro	Yes	–
Parking	MGC	–	Yes
Parking Pro	MGC-Pro	Yes	–
Toll / Toll Pro	MGC	–	Yes
Toll / Toll Pro	MGC-Pro	Yes	–
Toll HighSpeed	MGC	–	Yes
Toll HighSpeed	MGC-Pro	Yes	–
Traffic H1S	MGC-Pro	Yes	–
Traffic H1L	MGC-Pro	Yes	–

Table 2: Barrier types, control unit types, input and output functions

Digital inputs, digital outputs and output relays

2.2 Digital inputs

Improper parameterization and wiring

⚠ WARNING	
	<p>Risk of injury by improper parameterization and wiring of the control unit!</p> <p>Inappropriate parameterization and wiring can cause severe injuries!</p> <ul style="list-style-type: none"> – The parameterization and wiring of the control unit must only be carried out by qualified personnel or professional electricians. – The electrical connection of the signal generators to the IN1 to IN8 inputs must fit the parameterization.

MGC-Pro: Freely parameterisable input functions,
MGC: Firmly assigned input functions



NOTE!

For barriers with an MGC-Pro control unit, the functions of the digital inputs can be parameterized freely.

For barriers with an MGC control unit, the functions of the inputs are firmly assigned.

→ For an overview, see page 7, chapter 2.1.

→ For input and output parameterization, see page 20, chapter 3.

Factory settings for the vertical barriers "Access", "Parking" and "Toll"

Clamp	Description	Function
IN1	Input 1	Open low priority
IN2	Input 2	Open low priority
IN3	Input 3	Open vend count
IN4	Input 4	Open high priority
IN5	Input 5	Ext. opening loop exit
IN6	Input 6	Close
IN7	Input 7	Close
IN8	Input 8	Boom contact input

Table 3: Factory settings "Digital inputs" – "Access", "Parking" and "Toll"

Digital inputs, digital outputs and output relays

Factory settings for the horizontal barriers "Traffic H"

Clamp	Description	Function
IN1	Input 1	Open low priority
IN2	Input 2	Open low priority
IN3	Input 3	Open high priority
IN4	Input 4	Open Service
IN5	Input 5	Close Service
IN6	Input 6	Close
IN7	Input 7	Close
IN8	Input 8	Blink signal light

Table 4: Factory settings "Digital inputs" – Traffic H

Available input functions



NOTE!

The availability of the input functions depends on the control unit type and the barrier type. → For an overview, refer to page 7, chapter 2.1.

The functions have different priorities towards each other. The function "Open high priority" has the highest priority (priority 1). I.e. all other functions, such as "Open low priority", "Close", etc. are ignored if the function "Open high priority" is active.

For barriers with an MGC-Pro control unit, service can invert specific inputs and therefore the assigned functions. The following table describes the functions in the delivery condition. No inputs are inverted in the delivery condition.

Function	Description
–	Not available for: Barriers with control unit "MGC" Inputs that you assign this function "–" to are deactivated.
Open high priority	Connect fire fighter switch, emergency opening contacts, etc. to this input. This input has the highest priority. The barrier opens when +24 V DC are applied to this input. While the signal is present, the barrier cannot be closed. This input must not be used for opening loops. This input function is superordinated to all other input functions.
Open low priority ■ Program modes 2, 4 to 8: Open low priority ■ Program mode 3: Close/Open	Depending on program mode, a permanent signal or pulse is required. ■ Program modes 2, 4 to 8: The barrier opens when +24 V DC are applied to this input. ■ Program mode 3: The barrier changes its state with every pulse, i.e. the barrier closes or opens.
Opening exit ¹⁾	Not available for: Barriers with control unit "MGC" or horizontal barriers "Traffic H" This function is used for selective counting, e.g. for permanent renters of a parking space.

Digital inputs, digital outputs and output relays

Function	Description
Open vend count ¹⁾	Not available for: Horizontal barriers "Traffic H" An internal vend count counts the pulses present at this input. The pulse must be present for approx. 100 to 300 ms. The reset behaviour of the vend count can be set by the "Reset behaviour" parameter. → Refer to page 50, chapter 3.14.4.
Close	Depending on program mode, a permanent signal or pulse is required. The barrier closes when +24 V DC are applied to this input.
Close low priority	Not available for: Barriers with control unit "MGC" The function "Close low priority" is subordinated to all opening functions. The barrier closes when +24 V DC are applied to this input.
Inhibit opening	Not available for: Barriers with control unit "MGC" or horizontal barriers "Traffic H" When +24 V DC are applied to this input, all opening commands except for the "Open high priority" and "Open exit" signals are ignored. This input function has no function in the program mode 1 to 4.
Inhibit opening loop	Not available for: Barriers with control unit "MGC" or horizontal barriers "Traffic H" If the input function is active, the barrier remains closed when the opening loop is driven on.
Inhibit signal light	Not available for: Barriers with control unit "MGC" Signal lights are no longer controlled when +24 V DC are applied to this input.
Ext. opening loop entry ¹⁾	Not available for: Barriers with control unit "MGC" or horizontal barriers "Traffic H" The barrier opens when +24 V DC are applied to this input. Connect external opening loops to this input.
Ext. opening loop exit ¹⁾	Not available for: Barriers with control unit "MGC" or horizontal barriers "Traffic H" The barrier opens when +24 V DC are applied to this input. Connect external opening loops to this input.
Ext. impact detection	You can install external impact detection to the barrier arm. While no vehicle touches the barrier arm from below, the input "Ext. impact detection" has +24 V DC applied. When the barrier arm impacts a vehicle, e.g. due to impermissible driving through of a vehicle, the +24 V DC are removed from the input "Ext. impact detection". The barrier's behaviour in case of impact detection can be set in the "Impact settings" menu. → Refer to page 53, chapter 3.14.5.
Boom contact input	Not available for: Barriers with control unit "MGC" The barrier is equipped with a arm release input in the flange. While the barrier arm is in its correct position, +24 V DC are applied to the "Boom contact input" input. When the barrier arm is moved from its position e.g. by a collision with a vehicle, the +24 V DC are removed from the "Boom contact input" input. The barrier moves into the "open" position. The arm contact must be activated in the menu "Boom contact settings". In the menu "Boom contact settings", the option "Enabled" must be chosen for the parameter "Disabled/Enabled". → Refer to page 69, chapter 3.17.2.

Digital inputs, digital outputs and output relays

Function	Description
Additional safety device	<p>Not available for: Barriers with control unit "MGC"</p> <p>For barriers of the Parking and Toll series, these functions can be assigned to input IN6.</p> <p>+24 V DC must be applied at this input for operation. You can implement this as follows:</p> <ul style="list-style-type: none"> ■ Via a safety device with potential-free contact ■ Via a wire bridge, connected to +24 V DC <p>The barrier cannot be closed if the input signal +24 V is interrupted.</p> <p>If the barrier is in the process of closing and the +24 V input signal is interrupted and the cut-off angle for the parameter "Safety loop close" is not undercut yet, the barrier opens again.</p> <p>This input must only be used in addition to the internal detector module and/or to the safety light barriers connected to clamp X11.</p>
Acknowledgement	<p>Not available for: Barriers with control unit "MGC" or horizontal barriers "Traffic H"</p> <p>This input is required for parallel operation. → For more information on parallel operation, see separate instructions.</p>
Blink signal light	<p>Not available for: Barriers with control unit "MGC"</p> <p>While +24 V DC are pending at the input, the lamps flash at 1 Hz.</p> <p>This input function overwrites the following settings:</p> <ul style="list-style-type: none"> ■ Parameter "Signal light A", all options ■ Parameter "Signal light B", all options except for "Light strip green". <p>You may use this function for special signalling like "Parking place assigned".</p>
Parking counter reset	<p>Not available for: Barriers with control unit "MGC" or horizontal barriers "Traffic H"</p> <p>Through this input, you can reset the lot counter to "0" by applying a +24 V DC-signal. → For other information, see separate instructions "ECN-module".</p>
Open Service	<p>Not available for: Barriers with control unit "MGC"</p> <p>To this input, you can connect, e.g., a key switch. The barrier opens in deadman mode while +24 V DC are applied to the input. The output function "Service mode active" is activated.</p> <p>Once the 24 V DC are no longer pending, the barrier arm position will depend on the program mode set and the input assignment again.</p>
Close Service	<p>Not available for: Barriers with control unit "MGC"</p> <p>To this input, you can connect, e.g., a key switch. The barrier closes in deadman mode while +24 V DC are applied to the input. The output function "Service mode active" is activated.</p> <p>Once the 24 V DC are no longer pending, the barrier arm position will depend on the program mode set and the input assignment again.</p>

1) This function is only sensible for automatic program modes 5 to 8.

Table 5: Function "Digital inputs"

Digital inputs, digital outputs and output relays

2.3 Digital outputs and output relays

MGC-Pro: Freely parameterisable output functions,
MGC: Firmly assigned output functions



NOTE!

For barriers with an MGC-Pro control unit, the functions of the digital outputs and outputs can be parameterized freely.

For barriers with an MGC control unit, the functions of the outputs are firmly assigned.

→ For an overview, see page 7, chapter 2.1.

→ For input and output parameterization, refer to page 20, chapter 3.

Factory settings for the vertical barriers "Access", "Parking" and "Toll"

Clamp	Description	Function
DO1	Digital output 1	Locking
DO2	Digital output 2	Pulse after passage
DO3	Digital output 3	Signal light A
DO4	Digital output 4	Signal light B
NO1	Relay 1	Open
NO2	Relay 2	Closed
NO3	Relay 3	Error
NO4/NC4	Relay 4	Loop active A
NO5/NC5	Relay 5	Loop active B
NO6/NC6	Relay 6	Signal light C

Table 6: Factory settings "Digital outputs" and "Relay outputs" – Access, Parking and Toll

Factory settings for the horizontal barriers "Traffic H"

Clamp	Description	Function
DO1	Digital output 1	Locking
DO2	Digital output 2	Impact detection
DO3	Digital output 3	Loop active A
DO4	Digital output 4	Loop active B
NO1	Relay 1	Open
NO2	Relay 2	Closed
NO3	Relay 3	Error
NO4/NC4	Relay 4	Boom angle 30 – 85°
NO5/NC5	Relay 5	Boom angle 60 – 85°
NO6/NC6	Relay 6	Service mode active

Table 7: Factory settings "Digital inputs" and "Relay outputs" – Traffic H

Digital inputs, digital outputs and output relays

Available output functions



NOTE!

The availability of the output functions depends on the control unit type and the barrier type. → For an overview, see page 7, chapter 2.1.

For barriers with an MGC-Pro control unit, the service can invert specific outputs and therefore the assigned functions. The following table describes the functions in the delivery condition. No outputs are inverted in the delivery condition.

Function	Description
–	Not available for: Barriers with control unit "MGC" Outputs that you assign this function "–" to are deactivated.
Error	When the control unit recognizes any "safety-relevant error" or "error", the output with this function is reactivated (Fail safe). → See operating instructions of the barrier, chapter "Event, warning and error messages on the display".
Warning	Not available for: Barriers with control unit "MGC" When the control unit recognizes any "warning", the output with this function is reactivated (Fail safe).
Closed	When the barrier is closed, the output with this function is active.
Open	When the barrier is open, the output with this function is active.
Closing	Not available for: Barriers with control unit "MGC" While the barrier closes, the output with this function is active.
Opening	Not available for: Barriers with control unit "MGC" While the barrier opens, the output with this function is active.
Boom angle	Not available for: Barriers with control unit "MGC" This function is used to set the upper and lower angles. When the barrier arm is within this angle range, the output with this function is active. When the barrier arm is outside of the angle range set, the output is inactive. After you have chosen the output function "Boom angle", you can set values between 0° and 90° via a menu for the lower and upper angle.
Pulse after passage ¹⁾	When a passage was detected and the barrier arm is above the cut off angle, this output emits a counter pulse of 300 ms with this function. Passage is possible in either direction.
Tailgating	Only available for: Barrier types Parking Pro and Toll with control unit "MGC PRO" If the special function "Stop at tailgating" is activated, the output will emit a pulse of 300 ms with this function when the barrier arm stops. With this pulse, you can trigger, e.g., a video recording.
Sliding door pulse	Not available for: Barriers with control unit "MGC" This output is used to control a sliding gate. When the barrier is open, the output with this function emits a counter pulse of 300 ms with this function.

Digital inputs, digital outputs and output relays

Function	Description
Boom contact FB	Not available for: Barriers with control unit "MGC" The barrier can optionally be equipped with a arm contact in the flange. When the arm contact triggers, the output with this function is deactivated (fail safe). The output is deactivated once the arm contact input is active again.
Signal light A	This output is used to control a signal light. The function of this output can be parameterized via the parameter "Signal mode A", page 66, chapter 3.17.1.
Signal light B	This output is used to control a signal light. The function of this output can be parameterized via the parameter "Signal mode B", page 66, chapter 3.17.1.
Signal light C	This output is used to control a signal light. The function of this output can be parameterized via the parameter "Signal mode C", page 66, chapter 3.17.1.
Locking	The barrier can optionally be equipped with an electro-mechanical locking. The behaviour of the barrier depends on the locking used. Use the menu "Locking" to select the version of the locking used → Refer to page 71, chapter 3.17.3.
Parallel operation	Not available for: Barriers with control unit "MGC" or horizontal barriers "Traffic H" This output can be used to operate two barriers synchronously. This output function must be activated via the menu "Master/Slave". → Refer to page 65, chapter 3.16.4. → For information on parallel operation, see separate instructions.
Acknowledgement	Not available for: Barriers with control unit "MGC" or horizontal barriers "Traffic H" This output is required for parallel operation. → For information on parallel operation, see separate instructions.
Impact detection	Not available for: Barriers with control unit "MGC" The output with this function is activated when an impact has been recognized. The output is deactivated once the barrier is in the end position again.
Barrier ready	Not available for: Barriers with control unit "MGC" The output with this function is deactivated (fail safe) if the reference run (homing) is completed and release has taken place. → Also refer to page 56, chapter 3.14.7 parameter description "Start-up behaviour".
Service mode active	Not available for: Barriers with control unit "MGC" The output with this function is activated in the following cases: <ul style="list-style-type: none"> ■ The service switch at the control unit is in the position "Service on". The red LED is on. ■ +24 VDC are connected to the input "Open Service". ■ +24 VDC are connected to the input "Close Service".
Safety active	The output with this function is activated when a safety signal is active and the barrier is above the set cut off angle. The safety signal can come from a safety loop, light barrier or a safety facility connected to the input "Additional safety device". → Input function "Additional safety device" see page 11.

Digital inputs, digital outputs and output relays

Function	Description
5 min perman. damping	The output with this function emits 0 V DC (fail safe), when a loop, a light barrier or the input "Additional safety device" is active for more than 5 minutes. When neither a loop nor a safety device is active, +24 V DC are output at this output.
1. Parking zone full	Not available for: Barriers with control unit "MGC" or horizontal barriers "Traffic H" The output with this function is activated when all lots of the 1st parking zone are occupied. → For other information, see separate instructions "ECN-module".
2. Parking zone full	Not available for: Barriers with control unit "MGC" or horizontal barriers "Traffic H" The output with this function is activated when all lots of the 2nd parking zone are occupied. → For other information, see separate instructions "ECN-module".
Up	Not available for: Barriers with control unit "MGC" While the barrier is opening or opened, the output with this function is active.
Down	Not available for: Barriers with control unit "MGC" While the barrier is closing or closed, the output with this function is active. This output signal can be used, e.g. as release signal for a ticket vending machine.
Loop active A ¹⁾	When the induction loop A is busy, the output with this function is active.
Loop active B ¹⁾	When the induction loop B is busy, the output with this function is active.
Loop active pulse A ¹⁾	Not available for: Barriers with control unit "MGC" When a vehicle drives into loop A (rising flank), the output with this function emits a pulse.
Loop active pulse B ¹⁾	Not available for: Barriers with control unit "MGC" When a vehicle drives into loop B (rising flank), the output with this function emits a pulse.
Loop inactive pulse A ¹⁾	Not available for: Barriers with control unit "MGC" When a vehicle drives out of loop A (falling flank), the output with this function emits a pulse.
Loop inactive pulse B ¹⁾	Not available for: Barriers with control unit "MGC" When a vehicle drives out of loop B (falling flank), the output with this function emits a pulse.

Digital inputs, digital outputs and output relays

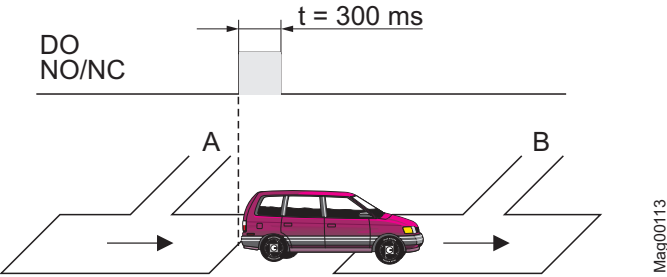
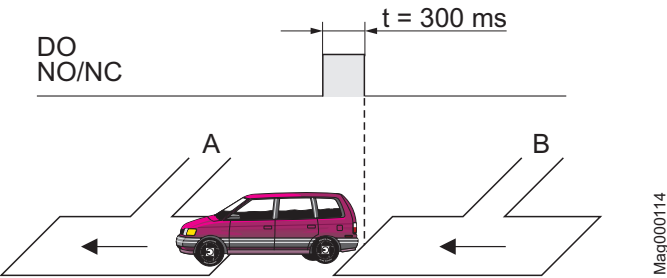
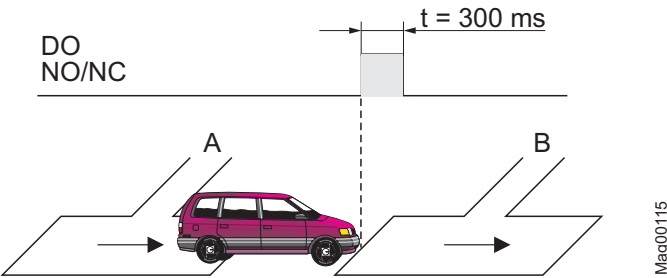
Function	Description
Direction 1 Pls A => B ¹⁾	<p>Not available for: Barriers with control unit "MGC"</p> <p>The vehicle drives from direction A to B. When the vehicle leaves loop A in the direction of loop B, this output emits a counter pulse of 300 ms.</p> 
Direction 1 Pls B => A ¹⁾	<p>Not available for: Barriers with control unit "MGC"</p> <p>The vehicle drives from direction B to A. When the vehicle leaves loop B in the direction of loop A, this output emits a counter pulse of 300 ms.</p> 
Direction 2 Pls A => B ¹⁾	<p>Not available for: Barriers with control unit "MGC"</p> <p>The vehicle drives from direction A to B. When the vehicle drives on loop A in the direction of loop B, this output emits a counter pulse of 300 ms.</p> 

Digital inputs, digital outputs and output relays

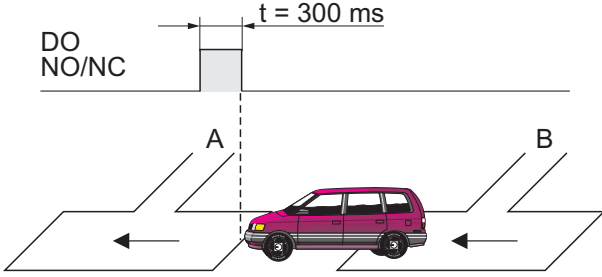
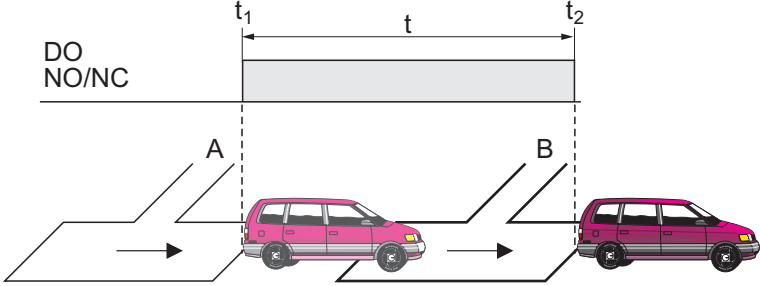
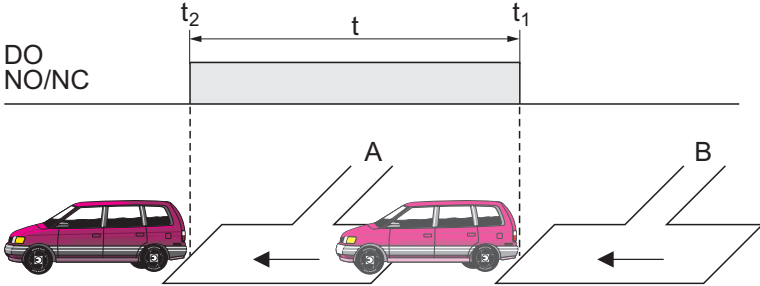
Function	Description
Direction 2 Pls B => A ¹⁾	<p>Not available for: Barriers with control unit "MGC"</p> <p>The vehicle drives from direction B to A. When the vehicle drives on loop B in the direction of loop A, this output emits a counter pulse of 300 ms.</p>  <p style="text-align: right;">Mag00116</p>
Direction 1 A => B ¹⁾	<p>Not available for: Barriers with control unit "MGC"</p> <p>The vehicle drives from direction A to B. When the vehicle leaves loop A, this output starts emitting a permanent signal. When the vehicle leaves loop B, this output stops the permanent signal. This function can be used, e.g. to control traffic lights.</p>  <p style="text-align: right;">Mag00117</p>
Direction 1 B => A ¹⁾	<p>Not available for: Barriers with control unit "MGC"</p> <p>The vehicle drives from direction B to A. When the vehicle leaves loop B, this output starts emitting a continuous signal. When the vehicle leaves loop A, this output stops the permanent signal. This function can be used, e.g. to control traffic lights.</p>  <p style="text-align: right;">Mag00118</p>

Digital inputs, digital outputs and output relays

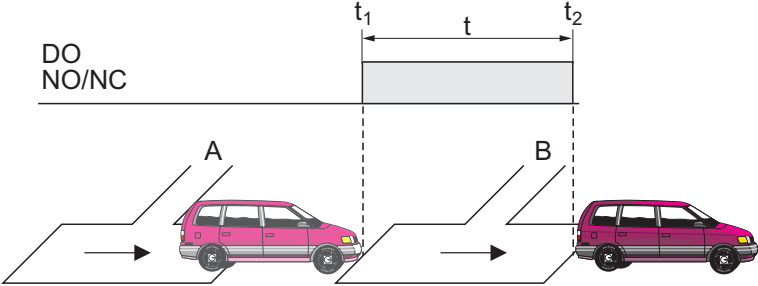
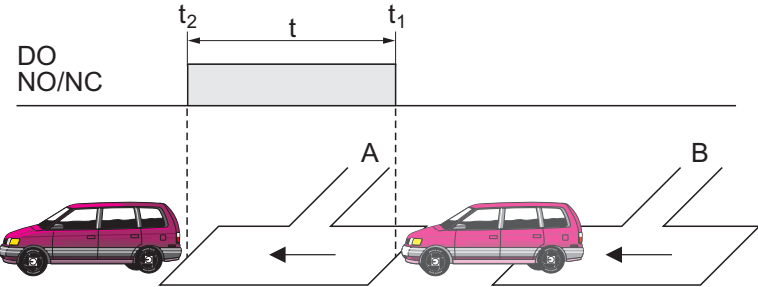
Function	Description
Direction 2 A => B ¹⁾	<p>Not available for: Barriers with control unit "MGC"</p> <p>The vehicle drives from direction A to B. When the vehicle enters loop B, this output starts emitting a continuous signal. When the vehicle leaves loop B, this output stops the permanent signal. This function can be used, e.g. to control traffic lights.</p> 
Direction 2 B => A ¹⁾	<p>Not available for: Barriers with control unit "MGC"</p> <p>The vehicle drives from direction B to A. When the vehicle enters loop A, this output starts emitting a continuous signal. When the vehicle leaves loop A, this output stops the permanent signal. This function can be used, e.g. to control traffic lights.</p> 
Light barrier occupied	<p>Not available for: Barriers with control unit "MGC"</p> <p>The output with this function is activated if the light barrier is occupied and the barrier boom is above the set cut off angle.</p>
Battery operation	<p>Not available for: Barriers with control unit "MGC"</p> <p>The output with this function is activated while the barrier is operated with a battery or rechargeable battery.</p>
Module-Open prior ²⁾	<p>Not available for: Barriers with control unit "MGC"</p> <p>This output function can be used to output the command "Open high priority" from the plug-in modules, such as "Ethernet", "Radio" or "RS485/422". In order to be able to open the barrier via Ethernet, radio or RS485/422, this output must be routed, e.g., via a jumper to the input "Open high priority". Release signals from the customer's side or loop feedback can be linked to the output signal accordingly.</p>

Digital inputs, digital outputs and output relays

Function	Description
Module-Open ²⁾	<p>Not available for: Barriers with control unit "MGC"</p> <p>This output function can be used to output the command "Opening" from the plug-in modules, such as "Ethernet", "Radio" or "RS485/422". In order to be able to open the barrier via Ethernet, radio or RS485/422, this output must be routed, e.g., via a jumper to the input "Open". Release signals from the customer's side or loop feedback can be linked to the output signal accordingly.</p>
Module-Close ²⁾	<p>Not available for: Barriers with control unit "MGC"</p> <p>This output function can be used to output the command "Closing" from the plug-in modules, such as "Ethernet", "Radio" or "RS485/422". In order to be able to open the barrier via Ethernet, radio or RS485/422, this output must be routed, e.g., via a jumper to the input "Close". Release signals from the customer's side or loop feedback can be linked to the output signal accordingly.</p>
External ³⁾	<p>Not available for: Barriers with control unit "MGC"</p> <p>The output function "External" permits superordinated control of the output through the plug-in modules, such as "Ethernet" or "RS485/422" and the "service module".</p>

1) This function is only available with the plug-in module "Detector" plugged in.

2) This function is only available with the plug-in module "Ethernet", "Radio" or "RS485/422" plugged in.

3) This function is only available with the plug-in module "Ethernet" or "RS485/422" or the "service module" plugged in.

Table 8: Function "Digital outputs" and "Output relay"

Parameterizing control unit

3 Parameterizing control unit

3.1 Safety

→ See operating instructions of the barrier, chapter "Occupational safety and special dangers".

Improper parameterization

⚠ WARNING	
	<p>Risk of injury by improper parameterization of the control unit!</p> <p>Improper parameterization of the control unit can lead to severe injuries!</p> <ul style="list-style-type: none">– The parameterization of the control unit may only be carried out by qualified personnel or professional electricians.– The electrical connection of the signal generators to the IN1 to IN8 inputs must fit the parameterization.

3.2 Changing menu language

The default setting in the control unit MGC is the menu language "English".

The menu language can be switched as follows:

1. The operating view is displayed.

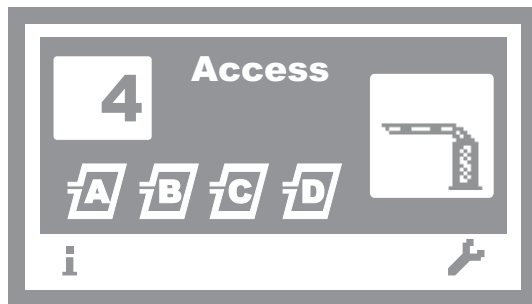



Fig. 1: Example "Operational view"

2. Press right control button 

Parameterizing control unit

- Access to parameterization can be password-protected. If password protection was activated, you are asked to enter a password.

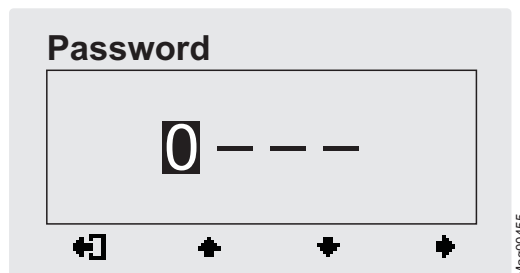

Fig. 2: View "Password"

- The "Main menu" menu is displayed. The "Function" menu has a dark background and is thus selected.

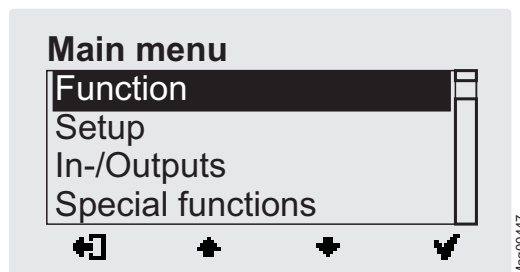



Fig. 3: View "Main menu – Function"

- Select the menu "System" with the two middle buttons , .

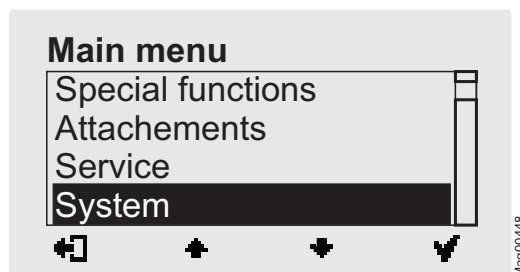



Fig. 4: View "Main menu – System"

- Confirm selection with the right control button . The following view is displayed. The menu "Language" is chosen.

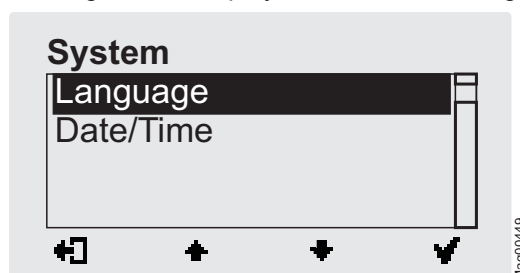



Fig. 5: View "Language"

Parameterizing control unit

7. Confirm selection with the right control button . The following view is displayed. The menu language "English" is chosen.

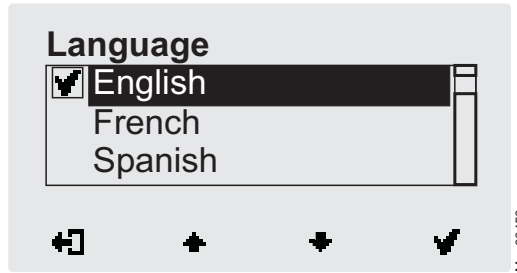



Fig. 6: View "Language" – English"

8. Select the language "German" with the two middle buttons  and . The language "German" has a dark background.

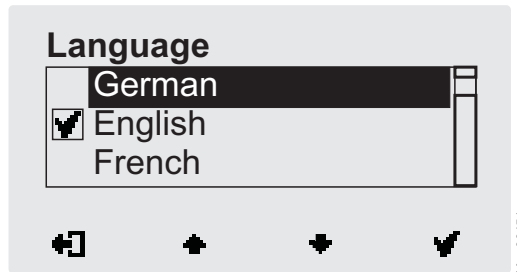



Fig. 7: View "Language" – German"

9. Use the right button  to select the new menu language. Your selection is marked with the symbol .

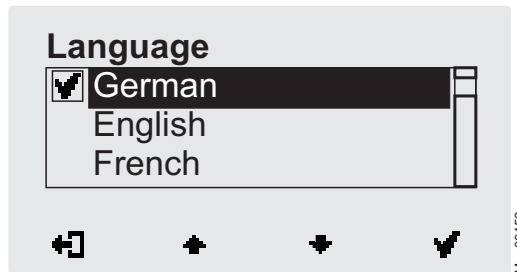



Fig. 8: View "Language" – German, step 2"

10. Use the left button  to leave the "Language" menu. The safety prompt "Save changes? " appears.

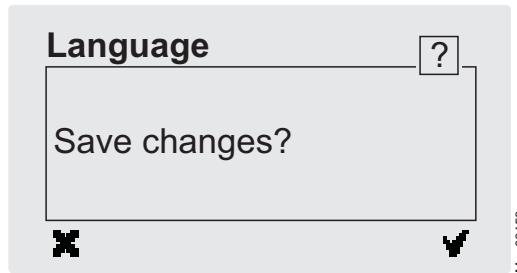



Fig. 9: View "Safety prompt – Save changes?"

Parameterizing control unit

Push the left button  if you do not want to save the changes. The menu language "English" remains active.



- Confirm safety prompt with the right control button . The new menu language "German" is activated. The following view is displayed:



Fig. 10: View "Menu System –
Menu language "German" is activated

- Press the left button  repeatedly until the operating view is displayed again. → Refer to page 20, Fig. 1.

3.3 Entering password

You need to enter a password in the following cases:

- You would like to change parameters in the control unit and the password protection was activated.
- You would like to reset the parameters to factory settings.
- You would like to delete the assignment between all hand transmitters and the plug-in module "Radio remote control".

- If a password is required, the following view is displayed:

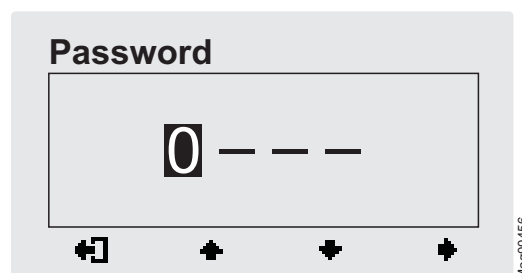



Fig. 11: View "Password"

- Use the two middle buttons  ,  to enter the first digit of the password.

Parameterizing control unit

- Use the right button  to select the second digit of the password. The following view is displayed:

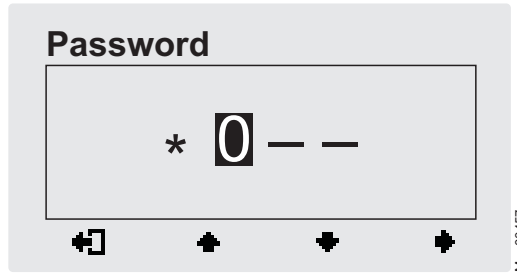







Fig. 12: View "Enter second digit of the password"

- Use the two middle buttons ,  to enter the second digit of the password.
- Use the right button  to select the third digit of the password.
- Use the two middle buttons ,  to enter the third digit of the password.
- Use the right button  to select the fourth digit of the password. The following view is displayed:

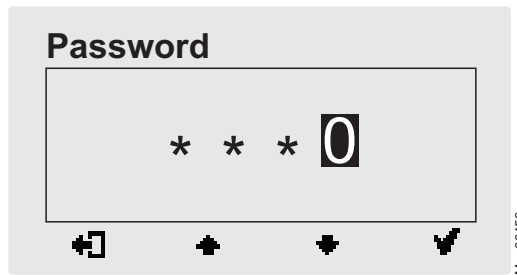





Fig. 13: View "Enter fourth digit of the password"

- Use the two middle buttons ,  to enter the fourth digit of the password.
- Confirm the password with the right control button .

Parameterizing control unit

3.4 Control elements control unit

Control elements control unit MGC
(Magnetic Gate Controller)

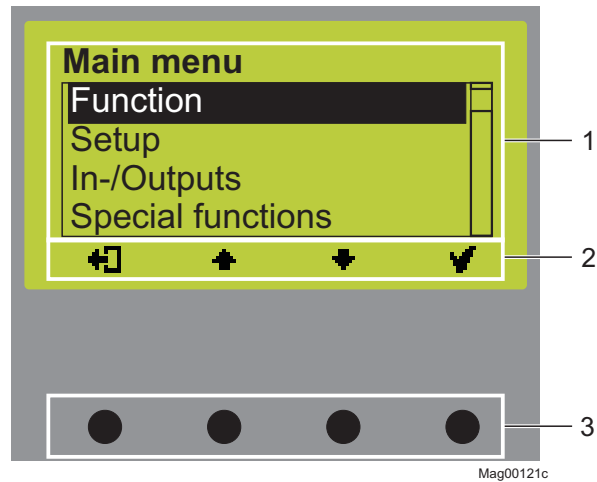

Fig. 14: Control unit elements MGC

- 1 Menu
- 2 Current function of the 4 control buttons
- 3 Control buttons

3.5 Displays on the control unit

Example "Operational view"

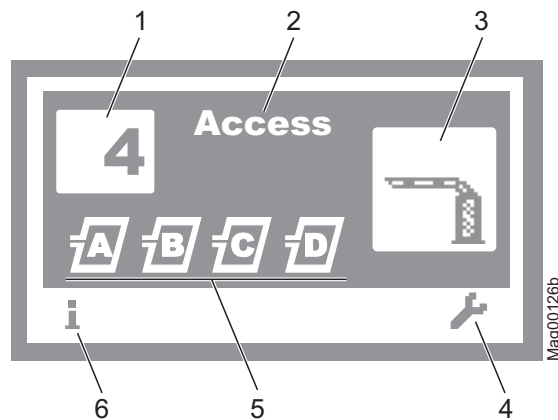

Fig. 15: Example "Operational view"

- 1 Program mode, here program mode 4
- 2 Barrier type, here type "Access"
- 3 Current state of the barrier, here barrier closed
- 4 Current function of the right control button, here calling menu "Main menu"
- 5 Current state of the induction loops
- 6 Current function of the left control button, here calling menu "Information"

Parameterizing control unit

Example "Screen change value"

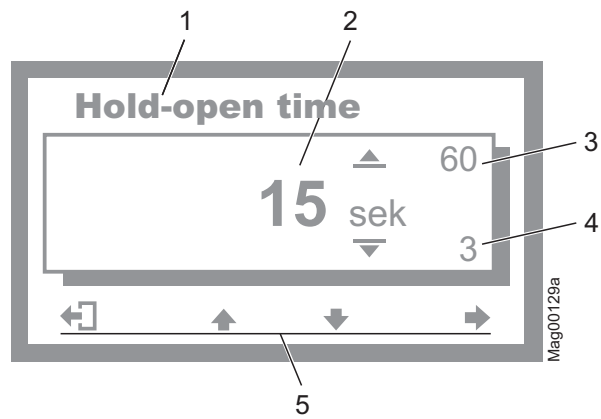

Fig. 16: Example "Screen Change value"

- 1 Parameter
- 2 Current value
- 3 Possible upper value
- 4 Possible lower value
- 5 Current functions control buttons

Parameterizing control unit**3.6 Symbols in the display****3.6.1 Control button functions**

The control unit is equipped with 4 control buttons. The function of the control buttons change depending on the current view in the display. The current functions are displayed.

Symbols	Description
	<ul style="list-style-type: none"> ■ Call menu "Information". ■ Scroll menu "Information".
	Perform loop reconciliation
	<ul style="list-style-type: none"> ■ Call menu "Main menu" Make all settings in the menu "Main menu". ■ Menu "Information" → Menu "Detector": Perform reference of the induction loops.
	Leave current menu level. The next-higher menu level is displayed.
	<ul style="list-style-type: none"> ■ Call next-lower menu level. ■ Select desired option or desired value. When the desired option was selected, the symbol is displayed.
	Option was selected but not yet stored
	<ul style="list-style-type: none"> ■ Within one menu level: Move cursor (market) upwards. ■ For setting value: Increase figure.
	<ul style="list-style-type: none"> ■ Within one menu level: Move cursor (market) downwards. ■ For setting value: Decrease figure.
	<ul style="list-style-type: none"> ■ Move cursor one position to the right. ■ Menu "Information" → Menu "Detector", for plug-in module "Detector (C-D)": Call view "Detector (C-D)" and switch between "Detector (A-B)" and "Detector (C-D)".
	Program mode "Service": Manually open the barrier.
	Program mode "Service": Manually close the barrier.
	<ul style="list-style-type: none"> ■ Delete error message. ■ When changing settings: Cancel changing process.

Table 9: Control button functions

Parameterizing control unit

3.6.2 Current state of the barrier

Vertical barriers "Access", "Parking" and "Toll"

Vertical barriers may have the following states:











Symbols	Description
	Barrier arm closed.
	Barrier arm open.
	Barrier open. Display of the counter of the opening pulses → See page 50, chapter 3.14.4
	Barrier arm opens.
	Closing signal was recognized. Traffic lights active. Barrier closes in 5 seconds. Time for traffic light lead is counted down.
	Barrier arm closes.
	Monitoring unit used.
	Barrier arm position unknown. "Homing" active.
	Barrier arm stopped
	An error, a warning or an event is present.
	The barrier arm is no longer in the flange. The arm contact has tripped.

Table 10: Current state of the barrier – vertical barrier

Parameterizing control unit**Horizontal barriers "Traffic H"**

Horizontal barriers may have the following states:















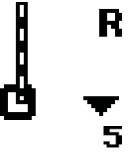

Close direction		Description
Left	Right	
L 	 R	Barrier open
L 	 R	Barrier closed
		Barrier is opening.
L 	 R	Closing signal has been recognized. Lead time active. Barrier closes in 5 seconds. Time for lead time is counting down.
		Barrier arm is closing.
L 	 R	Monitoring unit used
		Barrier arm position unknown. "Homing" (reference run of the barrier arm) is active.
		Barrier arm stopped
		An error, a warning or an event is present.
L 	 R	The barrier arm is no longer in the flange. The arm contact has tripped.

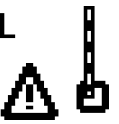
Table 11: Current state of the barrier – horizontal barrier

Parameterizing control unit

3.6.3 Current program mode

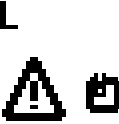
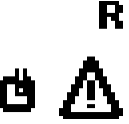

Symbols	Description
	Current program mode, here program mode 4 → For description of program modes, refer to page 34, chapter 3.11.
	Program mode "Service" → For description of program mode "Service", refer to page 44, chapter 3.11.9.

Table 12: Current program mode

3.6.4 Current state of the induction loops





Symbols	Description
	Loop A and B connected. The induction loop function is OK. If the icon flashes, the loop is occupied. If another "detector" plug-in module is connected, these induction loops are marked "C" and "D".
	The induction loop assumes the function of the safety loop. → Refer to page 75, chapter 3.22.
	Reference is performed.
	Induction loop deactivated.
	Induction loop defective.

Table 13: Current state of the induction loops

3.6.5 Further symbols





Symbols	Description
	Wrong password entered. Access denied.
	Reset values to factory settings. Enter the password "0000" for this.



Table 14: Further symbols

3.7 Setting display contrast

Setting display contrast

The display contrast of the control unit can be set after activation while the logo is still displayed. The logo is displayed for 3 seconds.

If you push one of the middle buttons , , the display time of the logo extends by 2 seconds per push. You can thus extend the time to set the display contrast.

- Increase contrast, display grows darker:  button.
- Reduce contrast, display grows lighter:  button.

The set display contrast is saved automatically.

3.8 Protecting parameterization from access

You can apply the access to the main menu with password protection.

→ Refer to page 73, chapter 3.18.













Parameterizing control unit

3.9 Parameterizing options





















→ Menu setup, refer to page 87.

→ Program modes overview, refer to page 34.

Example: Select program mode

1. The operating view is displayed. → Refer to page 25, Fig. 15.
2. Press right operating button .
3. The "Main menu" menu is displayed.
4. The "Function" menu is highlighted with a dark background and therefore selected. If required, select the "Function" menu with the two middle buttons  , .
5. Confirm selection with the right control button .
- 6- The "Program mode" menu has a dark background and is thus selected.
7. Confirm selection with the right control button .
8. A list with the possible program modes is displayed.
9. Select the desired program mode with the two middle buttons  , .
10. Use the right button  to select the new programming mode. Your selection is marked with the symbol .
11. Use the left button  to leave the "Program mode" menu.
12. The safety prompt "Save changes?" appears.
 - If the changes are to be saved, press the right button  . The new program mode is activated.
 - If the changes are not to be saved, press the left button  . The previous program mode remains active.
13. The menu "Function" is displayed.
14. Press the left button  repeatedly until the operating view is displayed again.

Parameterizing control unit**3.10 Parameterizing values****Example: Change hold-open time**

1. The operating view is displayed. → Refer to page 25, Fig. 15.
2. Press right operating button .
3. The "Main menu" menu is displayed.
4. Select the menu "Setup" with the two middle buttons , .
5. Confirm selection with the right control button .
6. Select the menu "Delays" with the two middle buttons , .
7. Press right control button .
8. The "Hold-open time" parameter is highlighted with a dark background and therefore selected. If required, select the "Hold-open time" parameter with the two middle buttons , .
9. Press right control button .
10. The current hold-open time value is displayed. The cursor flashes on the first digit.
11. Use the middle buttons ,  to set the desired digit.
12. Use the right button  to move the cursor to the right.
13. The cursor flashes on the second digit.
14. Use the middle buttons ,  to set the desired digit.
15. Press the right button .
16. Use the left button  to leave the "Hold-open time" parameter.
17. The safety prompt "Save changes?" appears.
 - If the changes are to be saved, press the right button . The new hold-open time is activated.
 - If the changes are not to be saved, press the left button .
18. The "Delays" menu is displayed.
19. Press the left button  repeatedly until the operating view is displayed again.

Parameterizing control unit

3.11 Overview program mode

3.11.1 Program modes for vertical barriers "Access", "Parking" and "Toll"

Overview program modes

For the MHTM™ MicroDrive vertical barriers "Access", "Parking" and "Toll", there are 8 program modes and the service mode.

Program modes 1 to 4 are manual modes. In the manual modes, the barrier must be closed manually after a drive through.

Program modes 5 to 8 are automatic modes. In the automatic modes, the barrier closes again automatically after a vehicle drives through.

Program	Description
1	Maintained contact
2	Deadman
3	Pulse control (bistable)
4	Two-Pulse control (Open/Closed button) (Factory setting)
5	Automatic (5): with hold-open time
6	Automatic (6): with hold-open time and decoupling of the opening loop at drive through in the opposite direction
7	Automatic (7): without hold-open time
8	Automatic (8) without hold-open time and decoupling of the opening loop at drive through in the opposite direction
	Service

Table 15: Program modes – vertical barriers "Access", "Parking" and "Toll"

Select program mode

→ Another program mode can be selected pursuant to chapter 3.7, page 31.



NOTE!

For reasons of safety, the first barrier arm motion after program mode change is performed at slow speed.

Parameterizing control unit**3.11.2 Program modes for horizontal barriers "Traffic H"****Overview program modes**

For the MHTM™ MicroDrive horizontal barriers "Traffic H", there are 4 program modes and the service mode.

Program modes 1 to 4 are manual modes. In the manual modes, the barrier must be closed manually.

Program	Description
1	Maintained contact
2	Deadman (Factory setting)
3	Pulse control (bistable)
4	Two-Pulse control (Open/Closed button)
	Service

Table 16: Program modes – horizontal barriers "Traffic H"

Select program mode

→ Another program mode can be selected pursuant to chapter 3.7, page 31.

**NOTE!**

For reasons of safety, the first barrier arm motion after program mode change is performed at slow speed.

Parameterizing control unit

3.11.3 Mode 1: Maintained contact

Typical application

The mode "Maintained contact" is suitable for vertical barriers, e.g. for the control of parallel operation of two barriers.
 → Refer to page 65, chapter 3.16.4 "Master/Slave".

The mode "Maintained contact" is suitable for control of horizontal barriers via a switch.

Function

The barrier is controlled only by one switch.
 When the switch is closed, the barrier closes. When the switch is opened, the barrier opens.

Supported input functions

Direction	Input function	Signal type
Open	Open high priority (priority 1)	Impulse signal
Close	Close (priority 2)	Permanent signal

Table 17: Supported input functions "Maintained contact"

→ Also refer to page 8, chapter 2.2 "Digital inputs".

3.11.4 Mode 2: Deadman

Typical application

For vertical barriers, the mode "Deadman" is suitable on parking places and factory premises. The barrier must be operated by a porter.

For horizontal barriers, the mode "Deadman" is suitable for use in production lanes, controlled by a subordinate control.

Function

The barrier is operated by two buttons.
 While the button "Open" is pressed, the barrier opens. While the button "Close" is pressed, the barrier closes. If no button is pressed, the barrier arm stops.



NOTE!

You can use the input function "Additional safety device" for a release signal for closing.

Parameterizing control unit**Supported input functions**

Direction	Input function	Signal type
Open	Open high priority (priority 1)	Permanent signal
	Open low priority (priority 3)	Permanent signal
Close	Close (priority 2)	Permanent signal

Table 18: Supported input functions "Deadman"

→ Also refer to page 8, chapter 2.2 "Digital inputs".

3.11.5 Mode 3: Pulse control (bistable)**Typical application**

This mode is suitable for barriers on factory premises, etc. that are little frequented by vehicles. The signal generator may be, e.g. a wireless button. The barrier must be operated by a person.

Function

The barrier is opened and closed by one command unit (pulse repetition). Every pulse changes the barrier's movement direction. The pulse must be present between 100 and 300 ms.

- 1. Signal: barrier opens
- 2. Signal: barrier closes
- 3. Signal: barrier opens

etc.

If another pulse is given during closing, the barrier opens. If another pulse is given during opening, the barrier opens completely and closes afterwards for reasons of safety.

Supported input functions

Direction	Input function	Signal type
Open	Open high priority (priority 1)	Impulse or permanent signal
Open and close alternately	Open low priority (priority 2)	Impulse or permanent signal

Table 19: Supported input functions "Pulse control"

→ Also refer to page 8, chapter 2.2 "Digital inputs".

Parameterizing control unit

3.11.6 Mode 4: Two-pulse control (Open/Closed button)

Typical application

This mode is suitable for barriers on factory premises, etc. that are often frequented by vehicles. The barrier must be operated by a person.

Function

The barrier is opened and closed completely via two separate command units (signal). One pulse on the respective input is sufficient for opening or closing. The pulse must be present between 100 and 300 ms.

The input function "Open high priority" is superordinated to the input function "Close". This means that while a closing signal is applied, the barrier can be opened by the signal "Open high priority". When the opening signal is removed, the barrier closes again at once after opening completely.

The input function "Open low priority" is subordinated to the input function "Close". This means that while a closing signal is applied, a signal at the input "Open low priority" is ignored.

Supported input functions

Direction	Input function	Signal type
Open	Open high priority	Impulse or permanent signal
	Open low priority	Impulse or permanent signal
	Open vend count	Impulse signal
Close	Close	Impulse or permanent signal

Table 20: Supported input functions "Two-pulse control"

→ Also refer to page 8, chapter 2.2 "Digital inputs".

Parameterizing control unit**3.11.7 Automatic Modes 5 to 8:
Drive directions 1 – overview and differences**

The automatic modes are not available for horizontal barriers.

The automatic modes differ in their functions in drive direction 1 "Safety loop → Opening loop".

In drive direction 2 "Opening loop → Safety loop", the automatic modes are identical. → Refer to page 43, chapter 3.11.8.

Drive direction 1: "Safety loop →
Opening loop"

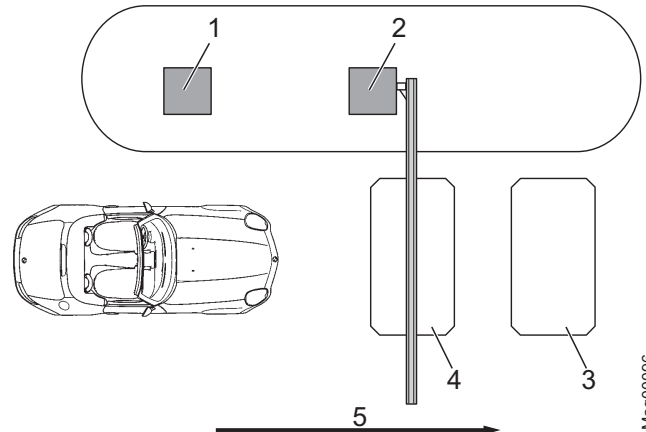

Fig. 17: Program modes 5 to 8, Passage in direction 1

- 1 Remote control, card reader, coin acceptor, etc.
- 2 Barrier
- 3 Opening loop
- 4 Safety loop
- 5 Passage in direction 1

Program mode	Hold-open time	Function Opening loop	Closing time drive backwards	Closing time without drive through
Automatic (5)	With hold-open time	The opening loop here acts as an ex- tended safety loop.	If a vehicle drives onto the safety loop and leaves it again backwards, the barrier closes.	Barrier closes after the end of the opening time or at a closing signal.
Automatic (6)		The opening loop does not act as an extended safety loop here.		
Automatic (7)	Without hold-open time	The opening loop here acts as an ex- tended safety loop.		Barrier closes after drive-through of the next vehicle or after the closing signal.
Automatic (8)		The opening loop does not act as an extended safety loop here.		

Table 21: Differences of automatic program modes 5 to 8, direction 1

Parameterizing control unit

Mode 5: Automatic (5)

Typical application

This mode is suitable for the automatic operation of a barrier, e.g. with card readers, remote control, coin accepters and induction loops or light barriers. Passage of the barrier is possible in either direction.

Function

The barrier is opened from direction 1 "Safety loop → Opening loop" with a pulse at the "Open low priority" input, e.g. with a card reader or coin accepter. The hold-open time that was set is also started.

When the vehicle leaves the safety loop, the hold-open time is deleted.

The barrier closes in the following cases:

- If the vehicle drives over both loops in direction 1, the barrier closes as soon as the vehicle leaves the opening loop. The opening loop here acts as an extended safety loop.
- If a vehicle drives onto the safety loop but leaves it again backwards, the barrier closes at once.
- If the vehicle drives over neither of the two loops, i.e. there is no drive through, the barrier closes after the end of the hold-open time.

→ For barriers with a safety light barrier but no safety loop installed see page 63, chapter 3.16.1.

Mode 6: Automatic (6)

Typical application

This mode is suitable for the automatic operation of a barrier, e.g. with card readers, remote control, coin accepters and induction loops or light barriers. Passage of the barrier is possible in either direction.

Function

The barrier is opened from direction 1 "Safety loop → Opening loop" with a pulse at the "Open low priority" input, e.g. with a card reader or coin accepter. The hold-open time that was set is also started.

When the vehicle leaves the safety loop, the hold-open time is deleted.

Parameterizing control unit

The barrier closes in the following cases:

- If the vehicle drives over both loops in direction 1 "Safety loop → Opening loop", the barrier closes as soon as the vehicle leaves the safety loop. The opening loop here does not act as an extended safety loop.
- If a vehicle drives onto the safety loop but leaves it again backwards, the barrier closes.
- If the vehicle drives over neither of the two loops, i.e. there is no drive through, the barrier closes after the end of the hold-open time.

→ For barriers with a safety light barrier but no safety loop installed see page 63, chapter 3.16.1.

Mode 7: Automatic (7)

Typical application

This mode is suitable for the automatic operation of a barrier, e.g. with ticket vending machines with internal logic. Passage of the barrier is possible in either direction.

Function

From direction 1 "Safety loop → Opening loop", the barrier is opened by an opening signal at one of the digital opening inputs. Hold-open time is not active in this mode.

The barrier closes in the following cases:

- If the vehicle drives over both loops in direction 1, the barrier closes as soon as the vehicle leaves the opening loop. The opening loop here acts as an extended safety loop.
- If a vehicle drives onto the safety loop but leaves it again backwards, the barrier closes.
- If the vehicle does not drive onto any of the two loops, the barrier remains open until a vehicle drives through or a closing signal is given.

→ For barriers with a safety light barrier but no safety loop installed see page 63, chapter 3.16.1.

Parameterizing control unit

Mode 8: Automatic (8)

Typical application

This mode is suitable for the automatic operation of a barrier, e.g. with ticket vending machines with internal logic. Passage of the barrier is possible in either direction.

Function

From direction 1 "Safety loop → Opening loop", the barrier is opened by an opening signal at one of the digital opening inputs. Hold-open time is not active in this mode.

The barrier closes in the following cases:

- If the vehicle drives over both loops in direction 1 "Safety loop → Opening loop", the barrier closes as soon as the vehicle leaves the safety loop. The opening loop here does not act as an extended safety loop.
- If a vehicle drives onto the safety loop but leaves it again backwards, the barrier closes.
- If the vehicle does not drive onto any of the two loops, the barrier remains open until a vehicle drives through or a closing signal is given.

→ For barriers with a safety light barrier but no safety loop installed see page 63, chapter 3.16.1.

Modes 5 to 8: Automatic (5) to (8) – supported input functions

Direction	Input function	Signal type
Open	Open high priority	Impulse or permanent signal
	Open low priority	Impulse or permanent signal
	Open vend count	Impulse signal
	Ext. opening loop entry	Impulse or permanent signal
	Ext. opening loop exit	Impulse or permanent signal
Close	Close	Impulse or permanent signal

Table 22: Supported input functions "Automatic (5) to (8)"

→ Also refer to page 8, chapter 2.2 "Digital inputs".

Parameterizing control unit**3.11.8 Automatic Modes 5 to 8: Drive direction 2**

In drive direction 2 "Opening loop → safety loop", the automatic modes are identical.

Closing barrier arm – maximum distance of the induction loops

⚠ WARNING	
	<p>Danger from closing arm!</p> <p>A closing arm may cause severe or lethal injury to persons, bicyclers, cabriolet drivers and motorcycle drivers!</p> <ul style="list-style-type: none"> – The maximum distance between opening loop and safety loop must be not greater than max. 1 m. In direction 2 "Opening loop → Safety loop", the barrier closes as soon as the vehicle leaves the opening loop. This means, if the distance is too large, the barrier closes before the car has cleared the barrier. → See operating instructions of the barrier, chapter "Design notes for induction loops".

Drive direction 2: "Opening loop → Safety loop"

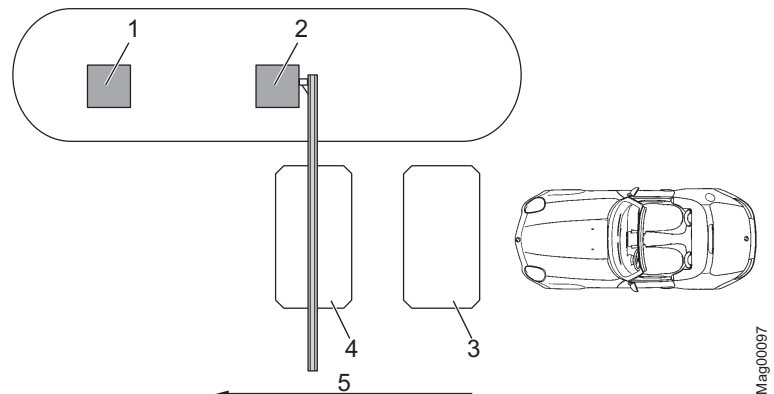

Fig. 18: Program modes 5 to 8, Passage in direction 2

- 1 Remote control, card reader, coin acceptor, etc.
- 2 Barrier
- 3 Opening loop
- 4 Safety loop
- 5 Passage in direction 2

In direction 2, the opening loop is driven on first. The barrier opens. While the opening loop or safety loop is occupied, the barrier remains open. When the vehicle has left both loops, the barrier closes.

Hold-open time is not active in drive direction 2.

When the vehicle leaves the opening loop backwards, the barrier closes at once.

Parameterizing control unit

3.11.9 Mode "Service "

In the "Service" mode, all opening and closing signals are ignored. The functions of safety devices like the safety loop or safety light barrier remain active for security reasons. This means that as soon as, e.g., the safety loop is occupied, the barrier cannot be closed.

Switch on Mode "Service "

Switch the "Service" switch for the "Service" mode. The LED lights red. The display backlighting flashes.

Switch off Mode "Service "

After the service work, the switch "Service" must be switched. The LED must light green.

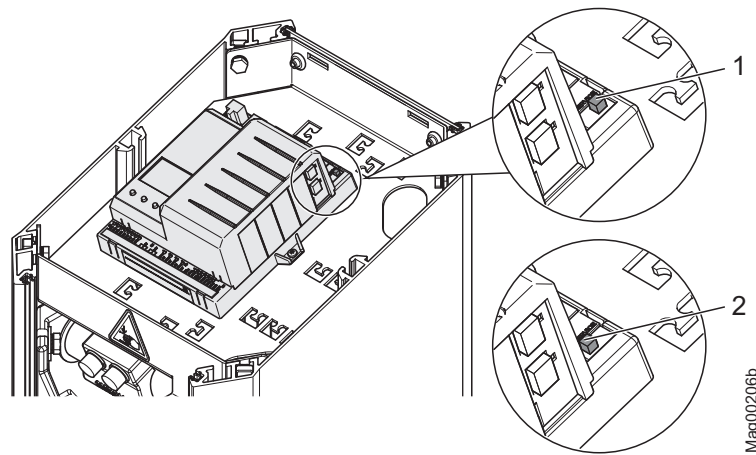



Fig. 19: Service switch

- 1 Mode "Service" on
- 2 Mode "Service" off

Button function

In the "Service" mode, you can control the motor with the two middle control buttons.

- Middle left button : Manually open the barrier.
- Middle right button : Manually close the barrier.



NOTE!

For reasons of safety, the first barrier arm motion after program mode change is performed at slow speed.

3.12 Menu "Information" (i)

Call and navigate

1. The operating view is displayed. → See page 25, Fig. 15.
2. Press left control button **i**.
3. Use the left control button **i** to scroll within the menu.
4. The "Information" menu is can be left as follows:
 - Press the left control button **i** repeatedly until the operating view is displayed again or
 - Press right control button **+** control button.

Operating view → Information	
Parameters	Description
Error, warning or event messages	Display of the error, warning or event messages that occurred since the last voltage reset, including date and time. Use the control buttons + and - to navigate through the messages. If no messages are present, the menu is not displayed.
Inputs	Displays the current settings for the digital inputs IN1 to IN8. For barriers with an MGC-Pro control unit, individual inputs can be deactivated or inverted. Deactivated inputs are marked with a "-", e.g. "IN8: -". Inputs with inverted functions are marked with a " ", e.g. "IN6: Open low priority".
Outputs	Displays the current settings for the digital outputs DO1 to DO4 and the relay outputs NO1 to NO3 and NO/NC4 to NO/NC6. For barriers with an MGC-Pro control unit, individual outputs can be deactivated or inverted. Deactivated outputs are marked with a "-", e.g. "DO2: -". Outputs with inverted functions are marked with a " ", e.g. "DO4: Signal light B".
Module info	Display of the software numbers (software #) and software versions (SW version) of the control unit and plugged-in plug-in modules.
Induction loops Detector (A-B), Detector (C-D)	Displays the current frequencies of the connected induction loops. The first plug-in module is displayed as "Detector (A-B)". The second plug-in module is displayed as "Detector (C-D)". The frequencies of induction loops A and B are displayed directly. To display the frequencies for the induction loops C and D, you have to press the button + . Use the button + you can switch the view between "Detector (A-B)" and "Detector (C-D)". → Also refer to page 75, chapter 3.22.

Table 23: Menu "Information"

Parameterizing control unit

3.13 Menu "Function"

3.13.1 Prog. mode (Program mode)

→ Refer to page 34, chapter 3.11.

3.13.2 Close direction

The parameter "Close direction" is only available for horizontal barriers.







Operating view → Main menu → Function → Close direction											
Parameters	Description										
Close direction	<p>Select the rotating direction to close. Observe that you can install the barrier arm on the shaft in any direction.</p> <p>Options</p> <ul style="list-style-type: none"> ■ Right: Rotating direction to close the barrier clockwise. ■ Left: Rotating direction to close the barrier counter-clockwise. <table border="1" style="width: 100%; text-align: center;"> <thead> <tr> <th>Barrier</th> <th>Close direction: "Right"</th> <th>Close direction: "Left"</th> </tr> </thead> <tbody> <tr> <td>Open</td> <td></td> <td></td> </tr> <tr> <td>Closed</td> <td></td> <td></td> </tr> </tbody> </table> <p>Factory setting</p> <ul style="list-style-type: none"> ■ Right 		Barrier	Close direction: "Right"	Close direction: "Left"	Open			Closed		
Barrier	Close direction: "Right"	Close direction: "Left"									
Open											
Closed											

Table 24: Parameter "Close direction"

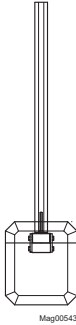
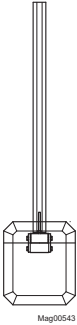
Parameterizing control unit**3.14 Menu "Setup"****3.14.1 Barrier speed**

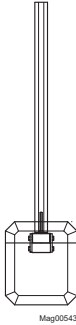
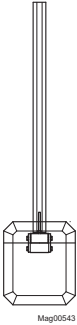
Operating view → Main menu → Setup → Barrier speed	
Parameters	Description
Close	<p>Select the closing speed for the barrier arm.</p> <p>The closing speed can be changed for all barrier types. The option "fast" corresponds to the barrier-specific speed (100 %).</p> <p>Options</p> <ul style="list-style-type: none"> ■ slow: approx. 50 % of the maximum speed ■ medium: approx. 70 % of the maximum speed ■ fast: maximum speed (barrier-specific speed) <p>Factory setting</p> <ul style="list-style-type: none"> ■ Access, Parking and Toll: fast ■ Traffic H1S, Traffic H1L: slow
Open	<p>Select the opening speed for the barrier arm. The option "fast" corresponds to the barrier-specific speed (100 %).</p> <p>The parameter is displayed for barrier types with the control unit MGC-Pro. → Refer to page 7, Table 2.</p> <p>Options</p> <ul style="list-style-type: none"> ■ slow: approx. 50 % of the maximum speed ■ medium: approx. 70 % of the maximum speed ■ fast: maximum speed (barrier-specific speed) <p>Factory setting</p> <ul style="list-style-type: none"> ■ Access, Parking and Toll: fast ■ Traffic H1S, Traffic H1L: slow

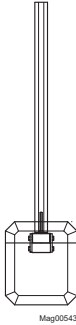
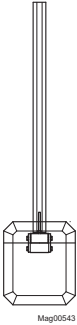
Table 25: Menu "Barrier speed"

3.14.2 Delays

Operating view → Main menu → Setup → Delays	
Parameters	Description
Hold-open time	<p>This parameter is not available for horizontal barriers "Traffic H".</p> <p>The parameter "Hold-open time" sets the hold-open time for the automatic program modes 5 and 6.</p> <p>The hold-open time is started by an opening pulse by a control unit, such as a card reader. A passage should occur during the set hold-open time. If no passage occurs during the hold-open time, the barrier closes automatically. When the vehicle drives on the safety loop, the hold-open time is deleted.</p> <p>Setting range</p> <ul style="list-style-type: none"> ■ 3 to 60 s <p>Factory setting</p> <ul style="list-style-type: none"> ■ 30 s

Parameterizing control unit

Operating view → Main menu → Setup → Delays	
Parameters	Description
Close delay	<p>The barrier only closes if the set time for the closing delay is over. The timer for closing delay is started with the closing signal. With this parameter, you can also set the "Lead time" in the "Signal light" menu to the same menu. → Refer to page 66, chapter 3.17.1.</p> <p>Setting range</p> <ul style="list-style-type: none"> ■ 0 to 15 s <p>Factory setting</p> <ul style="list-style-type: none"> ■ 0 s
Light barrier delay	<p>The barrier only closes if the set time for the light barrier delay is over. The timer for light barrier delay is started with clearance of the light barrier.</p> <p>Setting range</p> <ul style="list-style-type: none"> ■ 0 to 15 s <p>Factory setting</p> <ul style="list-style-type: none"> ■ 5 s
Impact delay	<p>After the control unit has recognized that, e.g., a vehicle roof was hit by the closing barrier arm, the control unit tries to close the barrier again after the set impact delay. Impact is possible if, e.g., a user tries to drive through the barrier without permission.</p> <p>The following conditions must be met for the barrier to close after the end of the impact delay:</p> <ul style="list-style-type: none"> ■ In the "Impact settings" menu, the parameter "Restart" must be set to "Automatic". ■ The safety devices, such as safety loop or safety light barrier must be clear. <p>→ Also refer to page 53, chapter 3.14.5 Menu "Impact settings"</p> <p>Setting range</p> <ul style="list-style-type: none"> ■ 5 to 30 s <p>Factory setting</p> <ul style="list-style-type: none"> ■ 5 s

Table 26: Menu "Delays"

3.14.3 Cut off angle

This parameter is not available for horizontal barriers "Traffic H".

Operating view → Main menu → Setup → Cut off angle	
Parameters	Description
Safety loop close	<p>This parameter serves to ensure that a closed barrier cannot be opened without authorization.</p> <p>If the barrier arm is below the angle set for "Safety loop close", signals from the safety devices such as safety loop or safety light barrier are ignored. I.e., the barrier closes completely below the angle set here.</p> <p>Setting range</p> <ul style="list-style-type: none"> ■ Access: 1 to 40° ■ Access XL, Access XL2 and Access XXL: 1 to 40° ■ Parking: 1 to 80° ■ Toll and Toll HighSpeed: 1 to 80°
Light barrier	<p>If the barrier arm is below the set angle for "Light barrier" during closing, the light barrier is ignored. I.e., the barrier closes completely below the angle set here even if the light barrier is covered.</p> <p>Setting range</p> <ul style="list-style-type: none"> ■ 1 to 40° <p>Factory setting</p> <ul style="list-style-type: none"> ■ 10°
Impact detection	<p>Where the barrier arm is below the set angle for impact detection during closing, impact detection is deactivated. I.e., the barrier tries to close completely below the angle set here.</p> <p>Observe the length of the barrier arm when setting the angle. The barrier arm tip height at impact detection depends on the angle set and the barrier arm length.</p> <p>Setting range</p> <ul style="list-style-type: none"> ■ 1 to 40° <p>Factory setting</p> <ul style="list-style-type: none"> ■ 10°

Table 27: Menu "Cut off angle"

Parameterizing control unit

3.14.4 Vend count

This parameter is not available for horizontal barriers "Traffic H".

Operating view → Main menu → Setup → Vend count	
Parameters	Description
Reset behaviour	<p>Use this parameter to set vend count reset behaviour. The function "Vend count" is available for program modes 4 to 8. An internal vend count counts the pulses present at the input with the "Open vend count" function. The pulses are decremented only in driving direction 1 "Safety loop → Opening loop".</p> <p>Options</p> <ul style="list-style-type: none"> ■ No counter reset (without vend count reset) ■ Time-out The vend count is set to the value "0" if the vehicle does not pass the supervision device within the set hold-open time. ■ Reset on closing The vend count is set to value "0" when a closing signal is given. ■ Time-out/Reset on closing The vend count is set to the value "0" if the event "Time-out" or the event "Reset on closing" occurs. <p>Factory setting</p> <ul style="list-style-type: none"> ■ Time-out/Reset on closing
Counter	<p>This parameter shows the current counter reading of the vend count. The current counter is displayed in the operating view under the barrier symbol. If the counter is "zero", no number is displayed.</p>
Count open loop	<p>This function is sensible for systems where the opening loop is installed farther than one vehicle length away from the safety loop. The opening loop must be connected to a detector module. When using this function, passage is permitted in one direction only.</p> <p>Once the function is activated, passages over the opening loop are counted as pulse. The direction is not considered when decrementing the pulses.</p> <p>Options</p> <ul style="list-style-type: none"> ■ Deactivated [...] ■ Activated [X] <p>Factory setting</p> <ul style="list-style-type: none"> ■ Deactivated [...]

Table 28: Menu "Vend count"



NOTE!

By default, the internal vend count is decremented after safety loop and opening loop are driven over. In the following systems, the vend count is decremented after the safety loop is driven over already: No opening loop is activated or the option "Deactivated" was chosen for the parameter "Count open loop".

Parameterizing control unit**Example vend count
with program mode
"Automatic mode (5)"**

Drive direction 1: "Safety loop →
Opening loop"

This mode is suitable for the automatic operation of a barrier, e.g. with card readers, remote control, coin accepters and induction loops or light barriers. The control units and the barrier have a larger distance from each other. An internal vend count is incremented and decremented. The hold-open time counts down at the same time. Passage of the barrier is possible in either direction.

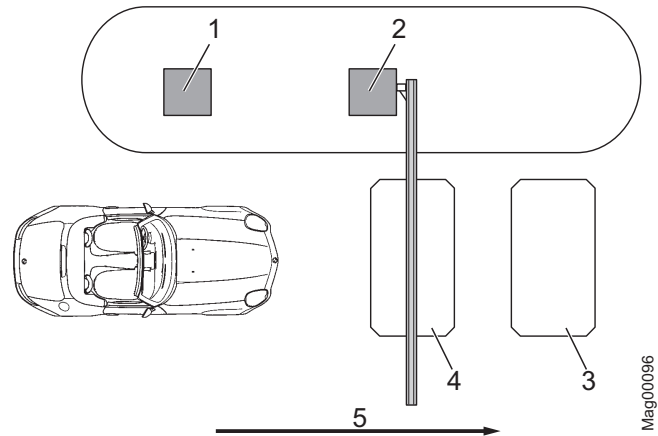

Fig. 20: Program mode 5 with vend count, Passage in direction 1

- 1 Remote control, card reader, coin acceptor, etc.
- 2 Barrier
- 3 Opening loop
- 4 Safety loop exit
- 5 Passage in direction 1

The barrier is opened from direction 1 "Safety loop → Opening loop" with a pulse at the "Open vend count" pulse, e.g. with a card reader or coin checking device. At the same time, an internal vend count is incremented. For the parameter "Count open loop", the option "Deactivated" is set.

After passage of the safety loop and the opening loop, the vend count is decremented again. When the internal vend count reaches the value "0", the barrier is closed.

Additionally, the vend count is set to the value "0" and the barrier closed in the following cases, depending on the settings for the "Vend count" parameter:

- The vehicle does not drive over the supervision facility within the set hold-open time.
- A closing signal is assigned.

Parameterizing control unit

The barrier closes in the following cases:

- If the vehicle drives over both loops in direction 1, the barrier closes as soon as the vehicle leaves the opening loop. The opening loop here acts as an extended safety loop.
- If a vehicle drives onto the safety loop but leaves it again backwards, the hold-open time is deleted and the barrier closes.
- If the vehicle drives over neither of the two loops, i.e. there is no drive through, the barrier closes depending on setting of the "Vend count" parameter.

Drive direction 2: "Opening loop → Safety loop"

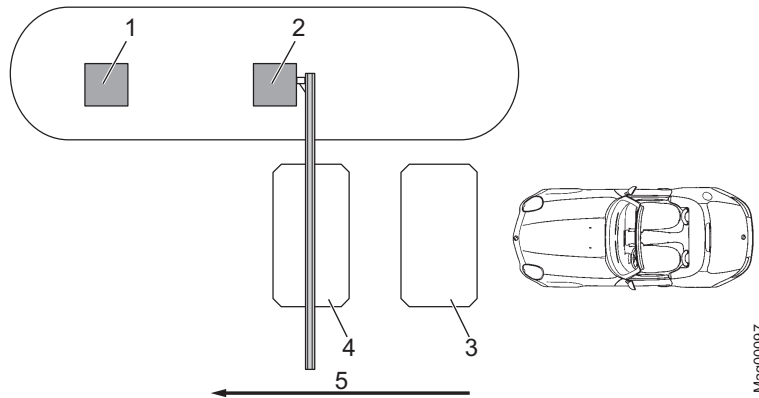

Fig. 21: Program mode 5 with pulse storage, Passage in direction 2

- 1 Remote control, card reader, coin acceptor, etc.
- 2 Barrier
- 3 Opening loop
- 4 Safety loop exit
- 5 Passage in direction 2

In direction 2, the opening loop is driven on first. The barrier opens. While the opening loop or safety loop is occupied, the barrier remains open. When the vehicle has left both loops will the barrier close.

From drive direction 2, vend count is not active.

When the vehicle leaves the opening loop backwards, the barrier closes at once.

3.14.5 Impact settings

Operating view → Main menu → Setup → Impact settings	
Parameters	Description
Impact response – Description for Access, Parking and Toll	<p>Select the barrier arm's impact reaction if the control unit detects an impact. → Refer to parameter "Impact detection" page 49, chapter 3.14.3.</p> <p>Select the barrier arm's impact reaction if the control unit detects an impact. This setting relates to the impact detection while the barrier arm closes. If an impact is recognized during opening, the barrier arm is stopped. The behaviour of the barrier after an impact can be set via the parameter "Restart". → See this table.</p> <p>Options</p> <ul style="list-style-type: none"> ■ Open After impact detection, the barrier arm is opened completely. ■ Stop After impact detection, the barrier arm's closing movement is stopped. ■ Safe stop After impact detection, the barrier arm's closing movement is first stopped and then slightly opened. <p>Factory setting</p> <ul style="list-style-type: none"> ■ Open
Impact response – Description for Traffic H	<p>Select the barrier arm's impact reaction if the control unit detects an impact. An impact is recognized in both rotating directions. The behaviour of the barrier after an impact can be set via the parameter "Restart". → See this table.</p> <p>Options</p> <ul style="list-style-type: none"> ■ Stop After impact detection, the barrier arm's movement is stopped. ■ Reverse After impact detection, the barrier arm is moved into the other rotating direction at once. ■ Safe stop After impact detection, the barrier arm is first stopped and then partially moved into the other rotating direction. <p>Factory setting</p> <ul style="list-style-type: none"> ■ Safe stop

Parameterizing control unit

Operating view → Main menu → Setup → Impact settings	
Parameters	Description
Impact delay	<p>After the control unit has recognized that, e.g., a vehicle roof was hit by the closing barrier arm, the control unit tries to close the barrier again after the set impact delay. Impact is possible if, e.g., a user tries to drive through the barrier without permission.</p> <p>The following conditions must be met for the barrier to close after the end of the impact delay:</p> <ul style="list-style-type: none"> ■ In the "Restart" parameter, the option must be set to "Automatic". ■ The safety devices, such as safety loop or safety light barrier, must be clear. <p>This parameter corresponds to the parameter "Impact delay" in the "Delays" menu. → Refer to page 47, chapter 3.14.2.</p> <p>Setting range</p> <ul style="list-style-type: none"> ■ 5 to 30 s <p>Factory setting</p> <ul style="list-style-type: none"> ■ 5 s
Restart	<p>Select behaviour of the barrier after impact recognition.</p> <p>Options</p> <ul style="list-style-type: none"> ■ Automatic The barrier arm automatically completes the started movement after the impact delay has run. ■ Signal For the barrier arm to complete the started movement, the matching signal (open/close) must be applied. <p>Factory setting</p> <ul style="list-style-type: none"> ■ Signal
Sensitivity	<p>Select the sensitivity for impact detection.</p> <p>Depending on the setting of the balancing springs, e.g. for the setting "Open" for the parameter, "Power failure", it is possible that an impact is recognized even though no obstacle has been hit. In this case, select a lower sensitivity. → For the parameter "Power failure", see page 61, chapter 3.14.8.</p> <p>Options</p> <ul style="list-style-type: none"> ■ Medium ■ High ■ Low <p>Factory setting</p> <ul style="list-style-type: none"> ■ Medium

Table 29: Menu "Impact settings"

3.14.6 Start-up settings

Use this menu to select the start-up settings of the barrier according to the following events:

- after switching on voltage supply
- after return of voltage
- after reset

Homing

When the barrier starts up, the barrier performs a homing run. The barrier arm is opened at reduced speed to the end position. This process is also called homing.

Operating view → Main menu → Setup → Start-up settings	
Parameters	Description
Start-up behav. (Start-up behaviour)	<p>Select start-up behaviour of the barrier. → Refer to page 56, chapter 3.14.7 "Start-up behav.".</p> <p>Setting range</p> <ul style="list-style-type: none"> ■ 1 ... 8 <p>Factory setting</p> <ul style="list-style-type: none"> ■ Access, Parking and Toll: 1 ■ Traffic H: 4
Stay closed	<p>Select start-up behaviour for the barrier when the barrier arm is in the "closed" position.</p> <p>Options</p> <ul style="list-style-type: none"> ■ Activated [X] If the barrier arm is in the "closed" position, the selected start-up behaviour is ignored. If the barrier arm is in any other position, the barrier will act according to the chosen start-up behaviour. Before homing, the barrier position is inspected. A short movement in the closing direction is performed to check if the barrier is closed. If the barrier is closed, the barrier remains closed until an opening signal is pending. The opening signal is used for homing. No release signal is required. ■ Deactivated [] The barrier behaves according to the selected start-up behaviour. <p>Factory setting</p> <ul style="list-style-type: none"> ■ Deactivated [...]

Table 30: Menu "Start-up settings"

Parameterizing control unit

3.14.7 Start-up behav. (Start-up behaviour)



NOTE!

The display messages "Waiting for passage" and "Waiting for release" can be confirmed with the left button of the control unit. Ensure that no persons or vehicles are present below the barrier arm. In operating modes 3 to 8, the barrier will close as soon as the message has been confirmed. In operating modes 1 and 2, a closing signal is still required after the message is confirmed.

→ For the factory settings, see page 55, overview parameters "Start-up behav.".

Operating view → Main menu → Setup → Start-up settings → Start-up behav.	
Option	Description
1	<p>Reference run In this option, the barrier initially performs a reference run. This means that the barrier opens completely at low speed.</p> <p>Release signal No release signal is required to close the arm.</p> <p>Closing behaviour</p> <ul style="list-style-type: none"> ■ Program modes 1 or 2: If a safety loop is installed, the barrier closes only after a vehicle has passed through and a permanent closing signal is pending. If only a safety light barrier is installed, no passage is required. The barrier closes at once when a permanent closing signal is applied. ■ Program modes 3 to 8: If a safety loop is installed, the barrier closes when the first vehicle has driven through. If only a safety light barrier is installed, the barrier closes at once when the voltage returns.

Parameterizing control unit

Operating view → Main menu → Setup → Start-up settings → Start-up behav.	
Option	Description
2	<p>Reference run In this option, the barrier initially performs a reference run. This means that the barrier opens completely at low speed.</p> <p>Release signal A release signal must be applied for the barrier to be ready for closing. The release signal can be applied even before the voltage returns. The release signal is given either by an external closing signal, by loss of an external opening signal or by pressing the left operating button at the control unit.</p> <p>Closing behaviour</p> <ul style="list-style-type: none"> ■ Program modes 1 or 2: If a safety loop is installed, the barrier closes only after a vehicle has passed through and a permanent closing signal is pending. If only a safety light barrier is installed, no passage is required. The barrier closes at once when a permanent closing signal is applied. ■ Program modes 3 to 8: If a safety loop is installed, the barrier closes when the first vehicle has driven through. If only a safety light barrier is installed, the barrier closes at once when the voltage returns.
3	<p>Reference run In this option, the barrier initially performs a reference run. This means that the barrier opens completely at low speed.</p> <p>Release signal A release signal must be applied for the barrier to be ready for closing. If the release signal is applied before return of voltage, the release signal is ineffective. In this case, the release signal must be revoked and applied again after the barrier opens. The release signal is given either by an external closing signal, by loss of an external opening signal or by pressing the left operating button at the control unit.</p> <p>Closing behaviour</p> <ul style="list-style-type: none"> ■ Program modes 1 or 2: If a safety loop is installed, the barrier closes only after a vehicle has passed through and a permanent closing signal is pending. If only a safety light barrier is installed, no passage is required. The barrier closes at once when a permanent closing signal is applied. ■ Program modes 3 to 8: If a safety loop is installed, the barrier closes only after the first vehicle has driven through. If only a safety light barrier is installed, the barrier closes at once when the voltage returns.

Parameterizing control unit

Operating view → Main menu → Setup → Start-up settings → Start-up behav.	
Option	Description
4	<p>Reference run In this option, the barrier arm stops initially. The barrier will only carry out a reference run after a release signal.</p> <p>Release signal A release signal must be applied for the barrier to carry out a reference run. If the release signal is applied before return of voltage, the release signal is ineffective. In this case, the release signal must be revoked and applied again. The release signal is given either by an external closing signal, by loss of an external opening signal or by pushing the left operating button at the control unit.</p> <p>Closing behaviour</p> <ul style="list-style-type: none"> ■ Program modes 1 or 2: If a safety loop is installed, the barrier closes only after a vehicle has passed through and a permanent closing signal is pending. If only a safety light barrier is installed, no passage is required. The barrier closes at once when a permanent closing signal is applied. ■ Program modes 3 to 8: If a safety loop is installed, the barrier closes only after the first vehicle has driven through. If only a safety light barrier is installed, the barrier closes at once when the voltage returns.
5	<p>Reference run In this option, the barrier arm stops initially. The barrier will only carry out a reference run after a release signal.</p> <p>Release signal A release signal must be applied for the barrier to carry out a reference run. The release signal can be applied even before the voltage returns. The release signal is given either by an external closing signal, by loss of an external opening signal or by pushing the left operating button at the control unit.</p> <p>Closing behaviour</p> <ul style="list-style-type: none"> ■ Program modes 1 or 2: If a safety loop is installed, the barrier closes only after a vehicle has passed through and a permanent closing signal is pending. If only a safety light barrier is installed, no passage is required. The barrier closes at once when a permanent closing signal is applied. ■ Program modes 3 to 8: If a safety loop is installed, the barrier closes only after the first vehicle has driven through. If only a safety light barrier is installed, the barrier closes at once when the voltage returns.

Parameterizing control unit

Operating view → Main menu → Setup → Start-up settings → Start-up behav.	
Option	Description
6	<p>Reference run In this option, the barrier arm stops initially.</p> <p>Release signal For a release signal must be applied for the barrier to carry out a reference run. Release takes place by pushing the left operating button at the control unit.</p> <p>Closing behaviour</p> <ul style="list-style-type: none"> ■ Program modes 1 or 2: The barrier closes at once when a permanent closing signal is applied. ■ Program modes 3 to 8: The barrier closes at once after the barrier reference run.
7	<p>Reference run In this option, the barrier initially performs a reference run. This means that the barrier opens at low speed.</p> <p>Release signal No release signal is required to close the arm.</p> <p>Closing behaviour</p> <ul style="list-style-type: none"> ■ Program modes 1 or 2: The barrier closes at once when a permanent closing signal is applied. ■ Program modes 3 to 8: If a safety loop is installed, the barrier closes only after the first vehicle has driven through or after closing. If only a safety light barrier is installed, the barrier closes at once when the voltage returns. <p> WARNING! Danger of injury from closing arm!</p> <ul style="list-style-type: none"> ■ Sight contact to the barrier is required when the voltage is switched on again. ■ No vehicles and persons must stand below the barrier when the closing signal is given.

Parameterizing control unit

Operating view → Main menu → Setup → Start-up settings → Start-up behav.	
Option	Description
8	<p>Reference run In this option, the barrier initially performs a reference run. This means that the barrier opens at low speed.</p> <p>Release signal No release signal is required to close the arm.</p> <p>Closing behaviour</p> <ul style="list-style-type: none"> ■ Program modes 1 or 2: The barrier closes at once when a permanent closing signal is applied. ■ Program modes 3 to 8: Barrier closes at once. <p> WARNING! Danger of injury from closing arm!</p> <ul style="list-style-type: none"> ■ Sight contact to the barrier is required when the voltage is switched on again. ■ No vehicles and persons must stand below the barrier when the closing signal is given.

Table 31: Menu "Start-up settings", parameter "Start-up behav."

3.14.8 Power failure

Operating view → Main menu → Setup → Power failure	
Parameters	Description
Power failure – Description for Access, Parking and Toll	<p>This parameter sets whether the barrier arm opens at power outage or opens or closes depending on the barrier arm position. The balancing springs must be set according to the selected option. → See operating instructions of the barrier, chapter "Check and set the balancing springs in the lever system".</p> <p>Options</p> <ul style="list-style-type: none"> ■ Unlocked With this option, the lever system of the closed barrier is unlocked; the barrier remains closed. The arm can be opened manually. If the arm angle is less than approx. 30°, the arm will close. If the barrier arm is above an angle of approx. 35°, the barrier arm opens. The balancing springs in the lever system must be set accordingly. ■ Open This option is only possible for the barrier types Access, Access Pro, Parking, Parking Pro, Toll and Toll Pro with a lane width of up to 3.5 metres. In this option, the barrier arm opens at power outage. The barrier arm is moved to the locked end position with the present residual energy of the mains unit and completely opened by the balancing springs of the lever system. The balancing springs must be set correctly and the barrier arm must not be kept in the closed position by external influence. ■ Locked For this option, the barrier arm behaviour depends on the barrier arm position at power outage. When the barrier is closed, it remains closed and the lever system remains locked. Manual opening of the barrier is not possible or requires considerable application of force. If the barrier arm is below an angle of approx. 30°, the barrier arm closes. If the barrier arm is above an angle of approx. 35°, the barrier arm opens. The balancing springs in the lever system must be set accordingly. <p>Factory setting</p> <ul style="list-style-type: none"> ■ Unlocked
Power failure – Description for Traffic H	<p>Use this parameter to choose whether the barrier is unlocked or remains locked at power failure. If the barrier arm is moving, the movement is continued as long as there still is any energy.</p> <p>Options</p> <ul style="list-style-type: none"> ■ Unlocked When the barrier arm is in one of the two end positions, the barrier arm is unlocked. The barrier arm remains in the current end position. Manual movement of the barrier arm is possible. ■ Locked When the barrier arm is in one of the two end positions, the barrier arm remains locked. The barrier cannot be opened manually, or only under considerable application of force. <p>Factory setting</p> <ul style="list-style-type: none"> ■ Locked

Table 32: Menu "Power failure"

Parameterizing control unit

3.15 Menu "In-/Outputs"

3.15.1 Inputs

→ Refer to page 8, chapter 2.2 "Digital inputs".

3.15.2 Outputs

→ Refer to page 12, chapter 2.3 "Digital outputs and output relays".

3.15.3 Inverted In-/Outputs









This menu is only intended for MAGNETIC's service and only accessible with a password.

For barriers with an MGC-Pro control unit, individual inputs and outputs therefore can have their assigned functions inverted. Customer-side additional relays for signal inversion are therefore not required.

Example: Inverting the function of the input IN2 "Open low priority"

The input IN2 is assigned the function "Open low priority". In the delivery condition and the program mode 4, the barrier opens when a voltage of 24 V is pending at input IN2.

If the barrier is to open as soon as a voltage of 0 V is pending at input IN2, the function "Open low priority" can be inverted as follows.

1. The operating view is displayed. → See page 25, Fig. 15.
2. Press right operating button .
3. The "Main menu" menu is displayed.
4. Confirm selection with the right control button .
5. Select the menu "In-/Outputs".
6. Confirm selection with the right control button .
7. Select the menu "Inverted In-/Outputs".
8. Confirm selection with the right control button .
9. Enter "Service Password".
10. Confirm password with the right control button .
11. Select the menu "Inputs".
12. Confirm selection with the right control button .
13. Select input "IN2 []".
14. Invert the function of inputs IN2 with the right button . Your selection is marked with the symbol [X].
15. Use the left button  to leave the "Setup" menu.

Parameterizing control unit

16. The menu "Inverted In-/Outputs" is displayed.
17. Press the left button  repeatedly until the operating view is displayed again.

Input IN2 and therefore the assigned function "Open low priority" is inverted. In the menu "Information (i)", the input IN2 with inverted function is marked with a "I"; in this example, it is "**IN2: I Open low priority**".

3.16 Menu "Special functions"

This menu is not available for the horizontal barriers "Traffic H".

3.16.1 Closure by light barrier

This menu is not available for the horizontal barriers "Traffic H".

Operating view → Main menu → Special functions → Closure by light barr.	
Parameters	Description
Closure by light barrier	<p>Use this parameter to select the closing behaviour for barriers with only one safety light barrier installed.</p> <p>If a safety loop is installed, the barrier closes only after the first vehicle has driven through in the automatic program modes 5 to 8. If only a safety light barrier is installed, the barrier will not close automatically after the first vehicle has driven through in the automatic program modes 5 to 8.</p> <p>Options</p> <ul style="list-style-type: none"> ■ Deactivated [...] In program modes 5 and 6, the barrier only closes if either a closing signal is applied or the hold-open time has passed. In program modes 7 and 8, the barrier only closes when a closing signal is applied. ■ Activated [X] In program modes 5 to 8, the barrier closes at once when a vehicle drives through the safety light barrier and after passage of the set time for the parameter "Light barrier delay". → Refer to page 47, chapter 3.14.2. <p>Factory setting</p> <ul style="list-style-type: none"> ■ Deactivated [...]

Table 33: Menu "Closure by light barr."

Parameterizing control unit

3.16.2 Closure by add. safety

This menu is not available for the horizontal barriers "Traffic H".

Operating view → Main menu → Special functions → Closure by add. safety	
Parameters	Description
Closure by add. safety (Closure by additional safety)	<p>This parameter is only displayed if the input function "Additional safety device" was assigned to an input.</p> <p>Options</p> <ul style="list-style-type: none"> ■ Deactivated [...] <ul style="list-style-type: none"> The barrier remains open after clearing of the additional safety device. ■ Active [X] <ul style="list-style-type: none"> The barrier closes after clearing of the additional safety device. <p>Factory setting</p> <ul style="list-style-type: none"> ■ Deactivated [...]

Table 34: Menu "Closure by additional safety"

3.16.3 Stop at tailgating

This menu is only available for the series "Parking" and "Toll".

Operating view → Main menu → Special functions → Stop at tailgating	
Parameters	Description
Stop at tailgating	<p>Use this parameter to choose the behaviour of the barrier arm at tailgating.</p> <p>Options</p> <ul style="list-style-type: none"> ■ Deactivated [...] <ul style="list-style-type: none"> If the safety loop is driven on above the cut-off angle for the parameter "Safety loop close" during closing, the barrier arm opens. When the safety loop is cleared, closing is continued. ■ Active [X] <ul style="list-style-type: none"> If the safety loop is driven on above the cut-off angle for the parameter "Safety loop close" during closing, the barrier arm stops. When the safety loop is cleared, closing is continued. <p>→ Also refer to page 49, chapter 3.14.3 Menu "Cut off angle"</p> <p>Factory setting</p> <ul style="list-style-type: none"> ■ Deactivated [...]

Table 35: Menu: "Stop at tailgating"

Parameterizing control unit**3.16.4 Master/Slave**

This menu is not available for the horizontal barriers "Traffic H".

Operating view → Main menu → Special functions → Master/Slave	
Parameters	Description
Master/Slave	<p>Activate and deactivate "Parallel operation" function. By activating the master/slave function, the corresponding inputs and outputs are switched automatically. → See separate instructions for information on parallel operation.</p> <p>Options</p> <ul style="list-style-type: none"> ■ Deactivated [...] ■ Activated [X] <p>Factory setting</p> <ul style="list-style-type: none"> ■ Deactivated [...]

Table 36: Menu "Master/Slave"

Parameterizing control unit

3.17 Menu "Attachments"

3.17.1 Signal light

The parameters "Signal mode A", "Signal mode B" and "Signal mode C" can be used to parameterize the function for the outputs "Signal light A", "Signal light B" and "Signal light C". → Refer to page 14, chapter 2.3.

You can connect three signal lights.

If you want to control light strips via the MAGNETIC control unit, you need to select the "Light strip red" option for "Signal mode A" and "Light strip green" for "Signal mode B".

Operating view → Main menu → Attachments → Signal light	
Parameters	Description
Signal mode A (continued on next page)	<p>Select function for output "Signal light A".</p> <p>The parameter "Lead time" can be used to parameterize the warning lamp so that it already lights up red or flashes before closing. The lead time is the time between the closing signal and commencement of the closing procedure.</p> <p>Options</p> <ul style="list-style-type: none"> ■ Traffic light (permanent signal for red/green signal lights): <ul style="list-style-type: none"> ■ Barrier closed: Traffic light red ■ Barrier opens: Traffic light red ■ Barrier open (upper end position): Traffic light off ■ Barrier closes (without lead time)/ closing time (with lead time): Traffic light red ■ Warning signal (connection of a visual or acoustic signal/ permanent signal before and during closing of the barrier): <ul style="list-style-type: none"> ■ Barrier closed: Warning signal off ■ Barrier opens: Warning signal off ■ Barrier open (upper end position): Warning signal off ■ Barrier closes (without lead time)/ closing time (with lead time): Warning signal red ■ Flashing light (flashing light connection/ flashing signal while the barrier opens or closes): <ul style="list-style-type: none"> ■ Barrier closed: Flashing light off ■ Barrier opens: Flashing light flashes at 2 Hz ■ Barrier open (upper end position): Flashing light off ■ Barrier closes (without lead time)/ closing time (with lead time): Flashing light flashes at 2 Hz ■ Boom lighting (barrier arm lighting connection/ permanent flashing signal except when the barrier is open): <ul style="list-style-type: none"> ■ Barrier closed: Lighting flashes at 2 Hz ■ Barrier opens: Lighting flashes at 2 Hz ■ Barrier open (upper end position): Lighting off ■ Barrier closes (without lead time)/ closing time (with lead time): Lighting flashes at 2 Hz

Parameterizing control unit

Operating view → Main menu → Attachments → Signal light	
Parameters	Description
Signal mode A (continued)	<ul style="list-style-type: none"> ■ Light strip red / Boom lighting / Flashing light <ul style="list-style-type: none"> ■ Barrier closed (lower end position): Red, permanent light ■ Barrier opens: Red flashes at 2 Hz ■ Barrier open (upper end position): Red off ■ Barrier closes (without lead time)/ closing time (with lead time): Red flashes at 2 Hz <p>Factory setting</p> <ul style="list-style-type: none"> ■ Light strip red
Signal mode B	<p>Select function for output "Signal light B".</p> <p>Options</p> <p>→ For the options "Traffic light", "Warning signal", "Flashing light", "Boom lighting", see parameters "Signal mode A".</p> <ul style="list-style-type: none"> ■ Light strip green <ul style="list-style-type: none"> ■ Barrier closed (lower end position): Green off ■ Barrier opens: Green off ■ Barrier open (upper end position): Green, permanent light ■ Barrier closes (without lead time)/ closing time (with lead time): Green off <p>Factory setting</p> <ul style="list-style-type: none"> ■ Light strip green
Signal mode C	<p>Select function for output "Signal light C".</p> <p>Options</p> <ul style="list-style-type: none"> ■ Traffic light (permanent signal for red/green signal lights): <ul style="list-style-type: none"> ■ Barrier closed: Traffic light red ■ Barrier opens: Traffic light red ■ Barrier open (upper end position): Traffic light off ■ Barrier closes (without lead time)/ closing time (with lead time): Traffic light red ■ Warning signal (connection of a visual or acoustic signal/ permanent signal before and during closing of the barrier): <ul style="list-style-type: none"> ■ Barrier closed: Warning signal off ■ Barrier opens: Warning signal off ■ Barrier open (upper end position): Warning signal off ■ Barrier closes (without lead time)/ closing time (with lead time): Warning signal red <p>Factory setting</p> <ul style="list-style-type: none"> ■ Warning signal

Parameterizing control unit

Operating view → Main menu → Attachments → Signal light	
Parameters	Description
Lead time	<p>In some application cases, it is required for reasons of safety that a warning signal for the following traffic lights up after before closing of the barrier. This warning signal must light up before the barrier closes. The warning signal is switched on with the closing signal and the lead time is started. The barrier closes only after the end of the set lead time.</p> <p>With this parameter, you can also set the "Closing delay" in the "Delay" menu to the same menu. → Refer to page 47, chapter 3.14.2.</p> <p>Setting range</p> <ul style="list-style-type: none"> ■ 0 to 15 s <p>Factory setting</p> <ul style="list-style-type: none"> ■ 0 s
Start event	<p>This parameter is not available for horizontal barriers "Traffic H".</p> <p>Select start event with which the lead time is started and the signal lights are switched.</p> <p>Options</p> <ul style="list-style-type: none"> ■ Closing signal ■ S-loop active/closing signal (safety loop/closing signal) The option "S-loop active/closing signal" is only sensible for the automatic program modes 5 to 8. If an opening signal is pending, the lead time is not started and the signal lights are not switched. <p>Factory setting</p> <ul style="list-style-type: none"> ■ Closing signal

Table 37: Menu "Signal light"

3.17.2 Boom contact settings

The barrier can optionally be equipped with a arm contact in the flange. In the "Toll" series, the arm contact is integrated by default and performed as a "Swing Away" or "Auto Swing Away".

Operating view → Main menu → Attachments → Boom contact settings	
Parameters	Description
Disabled/Enabled	<p>The barrier can optionally be equipped with an arm contact in the flange. The parameter "Disabled/Enabled" is used to select the behaviour of the input function "Boom contact input" and the output function "Boom contact FB". The functions must be selected. → Refer to page 10, chapter 2.2 and page 14, chapter 2.3.</p> <p>Options</p> <ul style="list-style-type: none"> ■ Disabled "Boom contact" is deactivated. The input "Boom contact input" has no function in this option. The output with the function "Boom contact FB" is deactivated once the arm contact triggers ■ Enabled "Boom contact" is activated. While the barrier arm is in the flange, 24 V DC are pending at the input with the function "Boom contact input". If the barrier arm is moved from its position, the +24 V DC are removed from the "Boom contact input" input. The barrier moves to the "Open" position. The output with the function "Boom contact FB" is deactivated once the arm contact triggers. <p>Factory setting</p> <ul style="list-style-type: none"> ■ Disabled
Automatic closing	<p>Select signal for closing of the barrier arm after arm release.</p> <p>Options</p> <ul style="list-style-type: none"> ■ Automatic The barrier arm automatically closes after the end of the delay time. ■ Signal For the barrier arm to close, a signal must be applied to the input with the function "Close" or "Close low priority". <p>Factory setting</p> <ul style="list-style-type: none"> ■ Automatic

Parameterizing control unit

Operating view → Main menu → Attachments → Boom contact settings	
Parameters	Description
Closing delay	<p>The parameters are only relevant in the following cases:</p> <ul style="list-style-type: none"> ■ The barrier is a "Swing Away" or "Auto Swing Away" design. ■ In the "Automatic closing" parameter, the option is set to "Automatic". <p>If a car drives against a "Swing Away" barrier arm, it snaps from the flange. In the "Swing Away" version, the barrier arm must be returned to the flange manually. In the "Auto Swing Away" version, the barrier arm automatically moves into the "open" position. When the position is reached, the barrier arm is locked in the flange by springs.</p> <p>After the barrier arm has caught again, the barrier closes after the time set here.</p> <p>Setting range</p> <ul style="list-style-type: none"> ■ 0 to 10 s <p>Factory setting</p> <p>10 s</p>

Table 38: Menu "Boom contact settings"

3.17.3 Locking

Operating view → Main menu → Attachments → Locking	
Parameters	Description
Locking	<p>The barrier can optionally be equipped with an electro-mechanical locking. Use the parameter "Locking" to choose the locking used and thus the behaviour of the barrier. The locking is controlled via the output function "Locking". → Also refer to page 14, output function "Locking".</p> <p>Options</p> <ul style="list-style-type: none"> ■ Without locking No arm locking present. ■ Boom locking The arm locking is installed in the barrier arm. The barrier arm is locked in the closed end position via the nesting posts. The locking is controlled via the output function "Locking". If a signal is present for opening, the arm lock is removed first. ■ Spring-loaded brake The spring-loaded brake is installed in the barrier housing. Once no voltage is pending anymore, e.g. at power outage or if the output "Locking" is deactivated, the spring-loaded brake blocks the lever system in the correct position. If the output "Locking" is activated, the spring-loaded brake is released. To ensure that the locking is safely released before any movement, short delays are inserted before the movements. At power failure and with the function "Spring-loaded brake" activated, no motor movement is initiated to prevent damage to the brake/locking. → Also refer to page 61, Chapter 3.14.8 "Power failure". ■ Motor lever lock (lever lock) this locking version blocks the opened barrier securely even when powered down. For this, the motor lever lock is activated. The motor lever lock can only be installed in the factory. <p>Factory setting</p> <ul style="list-style-type: none"> ■ Without locking

Table 39: Menu "Locking"

Parameterizing control unit

3.17.4 Battery backup

The menu "Battery backup" is used to set the opening and closing speed of the barrier arm during battery operation. The setting affects the battery life.

For standard operation, set the opening and closing speed of the barrier arm in the menu "Barrier speed". → Refer to page 47, chapter 3.14.1.

Operating view → Main menu → Attachments → Battery backup	
Parameters	Description
Battery backup	<p>Select opening and closing speed of the barrier arm.</p> <p>Options</p> <ul style="list-style-type: none"> ■ Normal speed: The opening and closing speed corresponds to the setting in the menu "Barrier speed". ■ Slowly after 200 cycles: The opening and closing speed is reduced to level "Slow" after 200 cycles. ■ Slow down directly: The opening and closing speed is reduced to the level "Slow" at once after switching to battery operation. <p>Factory setting</p> <ul style="list-style-type: none"> ■ Normal speed

Table 40: Menu "Battery backup"

Parameterizing control unit**3.18 Menu "Service"**

This menu is only intended for MAGNETIC's service and only accessible with a password.

Operating view → Main menu → Service	
Parameters	Description
Cycles	Display of the complete closing and opening processes
Lifetime	Display operating hours counter. The operating hours counter records the time, during which the barrier is live.
System time	Displays the internal date and the internal clock
Main menu password	<p>Activate and deactivate password protection for the main menu To activate a change of the settings, either call the operating view or switch the voltage supply on or off.</p> <p>Options</p> <ul style="list-style-type: none"> ■ Inactive You can change the main menu without entering a password. ■ Active You can change the main menu only after entering a password. The password is identical with the one for the menu "Service". <p>Factory setting</p> <ul style="list-style-type: none"> ■ Inactive

Table 41: Menu "Service"

Parameterizing control unit

3.19 Menu "System"

Operating view → Main menu → System	
Parameters	Description
Language	Select menu language. Options <ul style="list-style-type: none"> <input type="checkbox"/> German <input type="checkbox"/> English <input type="checkbox"/> French <input type="checkbox"/> Spanish <input type="checkbox"/> Italian <input type="checkbox"/> Portuguese <input type="checkbox"/> Swedish <input type="checkbox"/> Finnish <input type="checkbox"/> Norwegian <input type="checkbox"/> Danish <input type="checkbox"/> Estonian <input type="checkbox"/> Dutch Factory setting <ul style="list-style-type: none"> <input type="checkbox"/> English
Date/time	Correct date and time of the control unit MGC.

Table 42: Menu "System"

3.20 Menu "Information"

Operating view → Main menu → Information	
Parameters	Description
Serial no.	Displays the serial number of the control unit
Hardware version	Displays the present hardware version
Software #	Display of the present software number
SW version	Displays the present software version
Temperature	Displays the current temperature in the control unit
Logic voltage	Display of the logic voltage, from hardware version E
X20-EN	Display of the analogue voltage 0–10 V at the terminal "X20-EN", from hardware version E
PSU-FB	Feedback signal of the mains unit (for future expansions), from hardware version E

Table 43: Menu "Information"

3.21 Menu "Motor GW (Gateway)"

Operating view → Main menu → Motor GW (Gateway)	
Parameters	Description
Motor temperature	Display of the current motor temperature
SW version	Displays the present software version
Information	Displays information on the module "Motor GW". Serial number (serial no.), hardware version, software # and software version of the module "Motor GW" are displayed here.

Table 44: Menu "Motor GW (Gateway)"

3.22 Menu "Detector 1 (A-B)"

This menu is used to reference the induction loops A and B.

Operating view → Main menu → Detector 1 (A-B)	
Parameters	Description
Recalibration	Start reference of the induction loops (activate)
Mode A	<p>Select position and function of loop A.</p> <p>Options</p> <ul style="list-style-type: none"> ■ Disabled Induction loop is not present or not relevant for evaluation. ■ Enabled The induction loop state is put on the output with function "Loop active". Internally, the induction loop condition is not used. ■ Safety loop The induction loop assumes the function of the safety loop. ■ Open entry The induction loop assumes the function of the opening loop on the entry lane. ■ Open exit The induction loop assumes the function of the opening loop on the exit lane. ■ Presence entry The induction loop assumes the function of the presence loop on the entry lane. ■ Presence exit The induction loop assumes the function of the presence loop on the exit lane.
Mode B	<p>Select position and function of loop B.</p> <ul style="list-style-type: none"> ■ → For description, see parameter "Mode A".
Sensitivity A	<p>Set the response sensitivity of the induction loop A. The response sensitivity is divided into increments.</p> <p>Factory setting</p> <ul style="list-style-type: none"> ■ 5 <p>Setting range</p> <ul style="list-style-type: none"> ■ 0...9

Parameterizing control unit

Operating view → Main menu → Detector 1 (A-B)	
Parameters	Description
Sensitivity B	Set the response sensitivity of the induction loop B. → For description, see parameter "Sensitivity A".
Frequency setting	→ Refer to page 76, Table 46.
Special functions	→ Refer to page 77, Table 47.
Information	Displays information about the plug-in module "Detector 1 (A-B). Here, the serial number (SerNo), hardware version, software # and software version and of the plug-in module are displayed.

Table 45: Menu "Detector 1 (A-B)"

Operating view → Main menu → Detector 1 (A-B) → Frequency settings	
Parameters	Description
Freq. A	Displays the currently measured frequency for induction loop A
Freq. B	Displays the currently measured frequency for induction loop B
Freq. shift	Interference influences, e.g. from external loop detectors or induction loops of barriers close by can influence the frequency of loops A and B. Use the parameter "Freq. shift" to change the frequency values for loops A (channel A) and B (channel B) by approx. 10 % and thus reduce the influence of loops A and B. Options for channels A and B. <ul style="list-style-type: none"> ■ High: high frequency value ■ Low: low frequency value Factory setting <ul style="list-style-type: none"> ■ High
Ref.-Val. A	Displays the reference frequency for induction loop A
Ref.-Val. B	Displays the reference frequency for induction loop B

Table 46: Menu "Frequency settings"

Parameterizing control unit

Operating View → Main Menu → Detector 1 (A-B) → Special functions	
Parameter	Description
Switch ON Delay A	<p>The message "Loop occupied (loop active)" is delayed by the set time. During this time, vehicles can cross the loop without triggering a message.</p> <p>The delay will only be active in presence or opening loops. For safety loops, "occupied" is reported at once. → Refer to page 75, Parameter "Mode A".</p> <p>Observe that the conditions of the output functions "Direction..." may be unusable if the delay is activated. → Refer to page 16, starting at Parameter "Direction 1 Pls A => B".</p> <p>Setting range</p> <ul style="list-style-type: none"> ■ 0 s...20 s <p>Factory setting</p> <ul style="list-style-type: none"> ■ 0 s
Switch ON Delay B	<p>Setting the switch ON delay for channel B.</p> <p>→ For description, see parameter "Switch ON Delay A".</p>
Hold time (Recalibration)	<p>After the end of the hold time, "Loop free" is signaled and a recalibration of the loops is performed automatically. The hold time starts with occupation of the loop.</p> <div style="text-align: center;">  <p>WARNING! Danger of injury from closing barrier arm!</p> <p>Vehicles that park on the loop for the duration of the hold time are removed. Depending on the program mode and condition of the inputs closes the barrier.</p> </div> <p>Options</p> <ul style="list-style-type: none"> ■ Infinite: No automatic recalibration at permanent assignment ■ 5 min: Automatic recalibration at permanent occupation after 5 min ■ 10 min: Automatic recalibration at permanent occupation after 10 min ■ 60 min: Automatic recalibration at permanent occupation after 60 min <p>Factory setting</p> <ul style="list-style-type: none"> ■ Infinite
Automatic sensitivity boost (ASB)	<p>ASB means "Automatic Sensitivity Boost".</p> <p>The "ASB" function is needed to recognize trailer tow-bars or vehicles with a high ground clearance after loop occupation.</p> <p>Options</p> <ul style="list-style-type: none"> ■ Off: No increase of the sensitivity level ■ Medium: Increase chosen sensitivity level by 3 levels ■ High: Maximum sensitivity level <p>Factory setting</p> <ul style="list-style-type: none"> ■ Off

Table 47: Menu "Special functions"

Parameterizing control unit

3.22.1 Check the working frequency of the induction loops.

1. The operating view is displayed. → See page 25, Fig. 15.
2. Press the left control button **i** repeatedly, until the menu "Detector 1 (A-B)" is displayed.

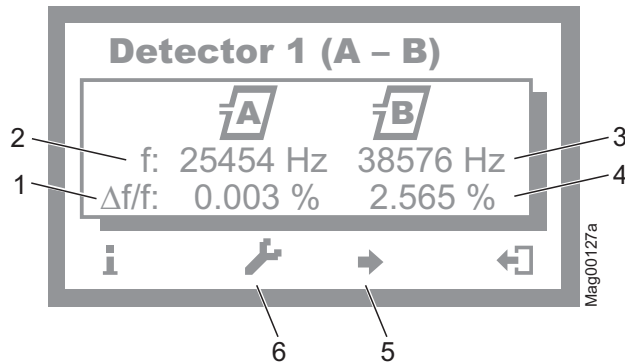

Fig. 22: Example "View – Menu Detector 1 (A-B)"

- 1 Relative frequency of induction loop A
 - 2 Currently measured frequency of induction loop A
 - 3 Currently measured frequency of induction loop B
 - 4 Relative frequency of induction loop B
 - 5 If another optional detector module is present:
Switching between the two detector modules
 - 6 Recalibration of the induction loop
3. Use the right button **➡** to leave the "Detector 1 (A-B)" menu. The operating view is displayed.

3.22.2 Reconciling and setting the operating frequency of the induction loop

Operating frequency requirements

The operating frequency must fulfil following requirements:

- When driving over the induction loop with a vehicle, a significant frequency increase must be measurable. Chose stage 5 or 6 for sensitivity. The relative frequency change ($\Delta f/f$) must be at least 0.1%. The higher the relative frequency increase, the higher the operating safety of the induction loop.
- The induction loops of a control unit operate alternating, and can therefore not affect each other. However, to avoid interferences by frequency coupling from external loop detectors or other control units in the direct proximity, a frequency clearance of at least 10000 Hz must be kept between them. For this, the menu "Freq. shift" is used to set the frequency option to "Low" or "High", or to deactivate or adjust the induction loop windings number.

Parameterizing control unit**Reference working frequency via the menu "Information" (i)**





















1. The operating view is displayed. → See page 25, Fig. 15.
2. Press left operating button **i**.
3. Press the left control button repeatedly, until the menu "Detector 1 (A-B)" is displayed. → See page 78, Fig. 22.
4. Press second operating button from the left **➤**.
5. The barrier is referenced. The loop symbols flash during reconciliation.
6. Check working frequencies. If required, perform settings like sensitivity, etc. in the menu "Detector 1 (A-B)" in the main menu.
7. Perform one of the following steps:
 - For a "Detector" plug-in module: Use the right button **➤** to leave the "Detector 1 (A-B)" menu. The operating view is displayed.
 - For two "Detector" plug-in modules: Press the third operating button from the left **➤**. The "Detector 2 (C-D)" menu is displayed.
8. The barrier is referenced. The loop symbols flash during reconciliation.
9. Check working frequencies. If required, perform settings like sensitivity, etc. in the menu "Detector 2 (C-D)" in the main menu.
10. Use the right button **➤** to leave the "Detector 2 (C-D)" menu. The operating view is displayed.

Parameterizing control unit

Frequency value of the un-assigned induction loop unstable

If the frequency value of an induction loop is unstable, this induction loop is influenced by an induction loop of another barrier or an external detector. The detector channels do not influence each other.

Depending on the loop geometry and settings of the external detector, set the menu "Freq. shift" to "Low" or "High".

1. The operating view is displayed. → See page 25, Fig. 15.
2. Press right operating button .
3. The "Main menu" menu is displayed.
4. Select the menu "Detector 1 (A-B)" with the two middle buttons , .
5. Confirm selection with the right control button .
6. The "Detector 1 (A-B)" menu is displayed.
7. Select the menu "Frequency settings" with the two middle buttons , .
8. Confirm selection with the right control button .
9. The "Frequency settings" menu is displayed.
10. Select the menu "Freq. Shift" with the two middle buttons , .
11. Confirm selection with the right control button .
12. The "Freq. Shift" menu is displayed.
13. Select the parameter "Channel A" or "Channel B" with the two middle buttons , .
14. Confirm selection with the right control button .
15. The corresponding menu is displayed.
16. Select the option "Low" or "High" for the respective channel with the two middle buttons , .
17. Use the right button  to select the option. Your selection is marked with the symbol .
18. Use the left button  to leave the menu.
19. The safety prompt "Save changes?" appears.
 - If the changes are to be saved, press the right button .
 - If the changes are not to be saved, press the left button .
20. Press the left button  repeatedly until the operating view is displayed again.
21. Test the operating frequencies.

For another plug-in module, the menu "Detector 2 (C-D)" is displayed in the main menu. Reconciliation is performed for the induction loops A and B.

3.23 Menu "Detector 2 (C-D)"

This menu is displayed if a second plug-in module with the function "Detector" was plugged into the control unit. This menu is used to reference the induction loops C and D.

The menu "Detector 2 (C-D)" corresponds to the menu "Detector 1 (A-D)". → Refer to page 75, chapter 3.22.

3.24 Menu "Radio control FM"

The "Radio control FM" menu is displayed when the "Radio" plug-in module is plugged into one of the control device slots.

The hand transmitters are available as 1-, 2- and 4-channel versions.

Each channel (button) can be assigned a function.

→ See page 82, parameter "Teach in remote control". e.g. you can open or close 4 barriers or open and close 2 barriers with a 4-channel version.

If you want to open and close a barrier via the hand transmitter, you have to assign the functions to the buttons row by row. Up to two functions per barrier can be taught in.

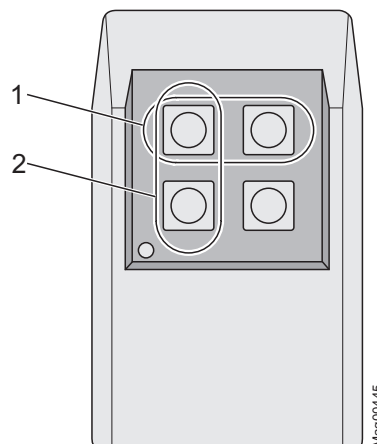

Fig. 23: 4-channel hand transmitter

- 1 Row
- 2 Column

If you want to operate the barrier via hand transmitter, program mode 3 to 8 must be selected.

The barrier is opened or closed by pressing the button on the hand transmitter. After pressing the button on the hand transmitter, the hand transmitter number is indicated in the display.

A radio module can manage up to 100 hand transmitters using different codes.

Parameterizing control unit

Operating view → Main menu → Radio control FM	
Parameters	Description
Number of transm.	Display of number of hand transmitters with which the barrier can be opened
Teach in remote control	Use this parameter to pair a hand transmitter with the radio module. Options <ul style="list-style-type: none"> ■ Open high priority The button is assigned to the function "Open high priority". ■ Open The button is assigned to the function "Open". ■ Close The button is assigned to the function "Close".
Delete remote control	Use this parameter to revoke a pairing between a hand transmitter and the radio module. Options <ul style="list-style-type: none"> ■ With remote control Dissolve pairing by pressing a button on the hand transmitter. ■ With number Dissolve pairing by entering the hand transmitter number. ■ Delete ALL Delete all hand transmitters. Password input is required for this.
Information	Displays information about the plug-in module "Radio". Here, the hardware version, software version and serial number (SerNo) of the plug-in module are displayed.

Table 48: Menu "Radio control FM"

Set hand transmitter code

The hand transmitter code is set via DIP switches in the hand transmitter. We recommend changing the DIP switches' standard settings.

1. Open hand transmitter housing. For this, press the colored pressure point while pulling up the upper housing part at the same time.
2. Change and document the DIP switches' settings.

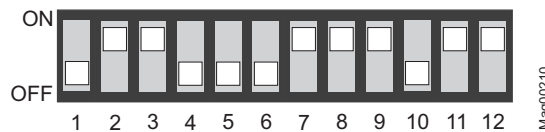





















Fig. 24: Example DIP switches settings

3. Close housing.

Parameterizing control unit**Teach in remote control
example option "Close"**

1. The operating view is displayed. → See page 25, Fig. 15.
2. Press right operating button .
3. The "Main menu" menu is displayed.
4. Select the menu "Radio control" with the two middle buttons , .
5. Confirm selection with the right control button .
6. Select the parameter "Teach in remote control" with the two middle buttons , .
7. Confirm selection with the right control button .
8. Select the parameter "Close" with the two middle buttons , .
9. The message "Press button" appears.
10. Press the button on the hand transmitter. For the 2-channel hand transmitter, the corresponding channel is paired with the radio module.
11. The message "Successful" appears on the display. The number for the parameter "Number of transm." is increased by one.
12. Press the left button  repeatedly until the operating view is displayed again.

Delete remote control

1. The operating view is displayed. → See page 25, Fig. 15.
2. Press right operating button .
3. The "Main menu" menu is displayed.
4. Select the menu "Radio control FM" with the two middle buttons , .
5. Confirm selection with the right control button .
6. Select the parameter "Delete remote control" with the two middle buttons , .
7. Confirm selection with the right control button .
8. The options "With remote control" and "With number" are displayed.
9. Select an option with the two middle buttons , .
10. Confirm selection with the right control button .

Option "With remote control"





The option "With remote control" was selected

1. The message "Press button" appears.
2. Press the button on the hand transmitter.
3. The message "Successful" appears. The number for the parameter "Number of transm." is decreased by one.
4. Press the left button  repeatedly until the operating view is displayed again.

Parameterizing control unit

Option "With number"

The option "With number" was selected

1. Enter hand transmitter number.
2. Use the left button  to leave the menu.
3. The safety prompt "Save changes?" appears.
 - If the hand transmitter is to be deleted, press the right button .
 - If the hand transmitter is not to be deleted, press the left button .
4. The "Delete remote control" menu is displayed.
5. Press the left button  repeatedly until the operating view is displayed again.

Option "Delete ALL"

The option "Delete ALL" was selected

1. Enter the service password.
2. Confirm input with the right control button .
3. The message "Successful" appears. All hand transmitters were deleted.



NOTE!

If a hand transmitter is deleted, the memory slot used is released. The sequence does not change by deletion. Teaching in new hand transmitters will first fill the gaps and only then continue numbering.

3.25 Factory settings



NOTE!

The parameters of the control unit are stored in the three memory areas "FW defaults", "Factory settings" and "User parameters".

The FW defaults are identical to the factory settings in these operating instructions. The FW defaults are firmly stored in the firmware and cannot be changed.

The factory setting can be assigned factory- or product-specific settings.

The user settings are the operating parameters.

Parameterizing control unit









Options in the menu "Factory settings"

The menu "Factory settings" offers the following options:

- Restore factory settings:
The stored parameters in the memory area "Factory settings" are assuaged as operating settings.
- User settings as factory settings:
The current parameter settings are stored as factory settings. These factory settings can be used to receive project-specific settings.
- FW defaults as factory setting:
The factory setting are overwritten by the FW standard values.











If you would like to assume the FW defaults as operating settings and the factory settings were overwritten first, you need to use the option "FW defaults as factory settings" and then the option "Restore factory settings".

Option "Restore factory settings"

1. The operating view is displayed. → See page 25, Fig. 15.
2. Press right operating button .
3. The "Main menu" menu is displayed.
4. Select the menu "Factory settings" with the two middle buttons , .
5. Confirm selection with the right control button .
6. Enter password "0 0 0 0".
7. Confirm password with the right control button .
8. The message "Reset to factory settings" appears.
9. Press right operating button .
10. The safety prompt "Save changes?" appears.
 - If the changes are to be saved, press the right button . The current settings are reset to factory settings. A restart is performed.
 - If the changes are not to be saved, press the left button .
11. Press the left button  repeatedly until the operating view is displayed again.

Parameterizing control unit

Via Service Password –
Option "Restore factory settings",
"User settings as factory settings"
or "FW standard values as factory
settings"

1. The operating view is displayed. → See page 25, Fig. 15.
2. Press right operating button .
3. The "Main menu" menu is displayed.
4. Select the menu "Factory settings" with the two middle buttons , .
5. Confirm selection with the right control button .
6. Enter the service password.
7. Confirm password with the right control button .
8. The message "Reset to factory settings" appears.
9. Select the desired option with the two middle buttons , .
10. Confirm selection with the right control button .
11. The safety prompt "Save changes?" appears.
 - If the changes are to be saved, press the right button .
The corresponding parameter set is written anew depending on the selected option. A restart is performed.
 - If the changes are not to be saved, press the left button .
12. Press the left button  repeatedly until the operating view is displayed again.

4 Menu setup

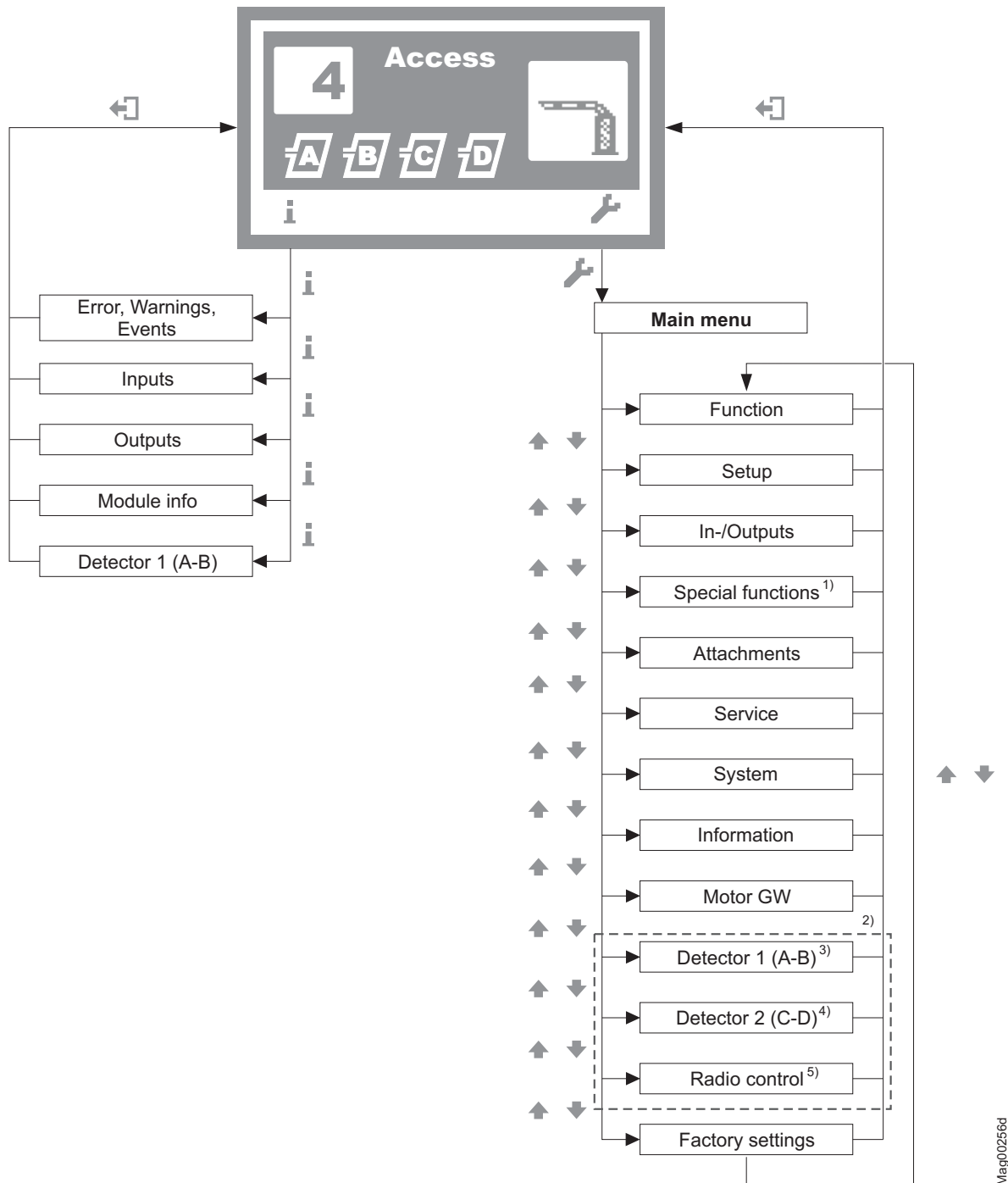
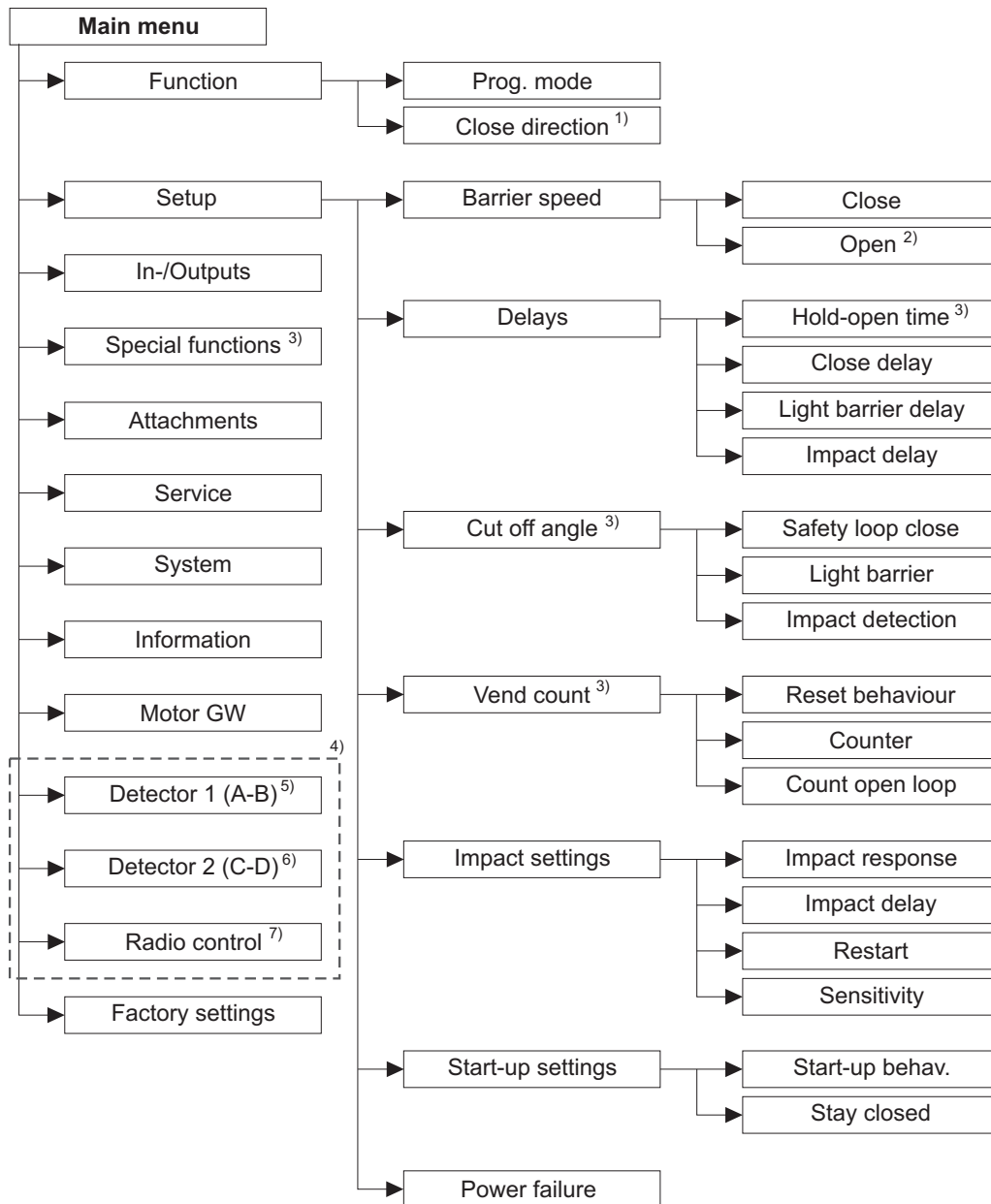

Fig. 25: Menu "Information" and main menu

- 1 Menu "Special functions" only for the barriers "Access", "Parking" and "Toll"
- 2 The view depends on the plugged-in plug-in modules such as "Ethernet" or "RS485/422" and on whether a service module is connected.
- 3 Menu "Detector 1 (A-B)" in the first plug-in module "Detector"
- 4 Menu "Detector 2 (C-D)" only with a second plug-in module "Detector" (optional)
- 5 Menu "Radio control" only with optional plug-in module "Radio"

Mag00256d

Menu setup



Mag001301

Fig. 26: Main menu – Menus "Function" and "Setup"

- 1 Parameter "Close direction" only for the barriers "Traffic H"
- 2 Parameter "Open" only for barriers with a control unit MGC-Pro
- 3 Parameter "Hold-open time" and menus "Special functions", "Cut off angle" and "Vend count" only for the barriers "Access", "Parking" and "Toll"
- 4 The view depends on the plugged-in plug-in modules such as "Ethernet" or "RS485/422" and on whether a service module is connected.
- 5 Menu "Detector 1 (A-B)" in the first plug-in module "Detector"
- 6 Menu "Detector 2 (C-D)" only with a second plug-in module "Detector" (optional)
- 7 Menu "Radio control" only with optional plug-in module "Radio"

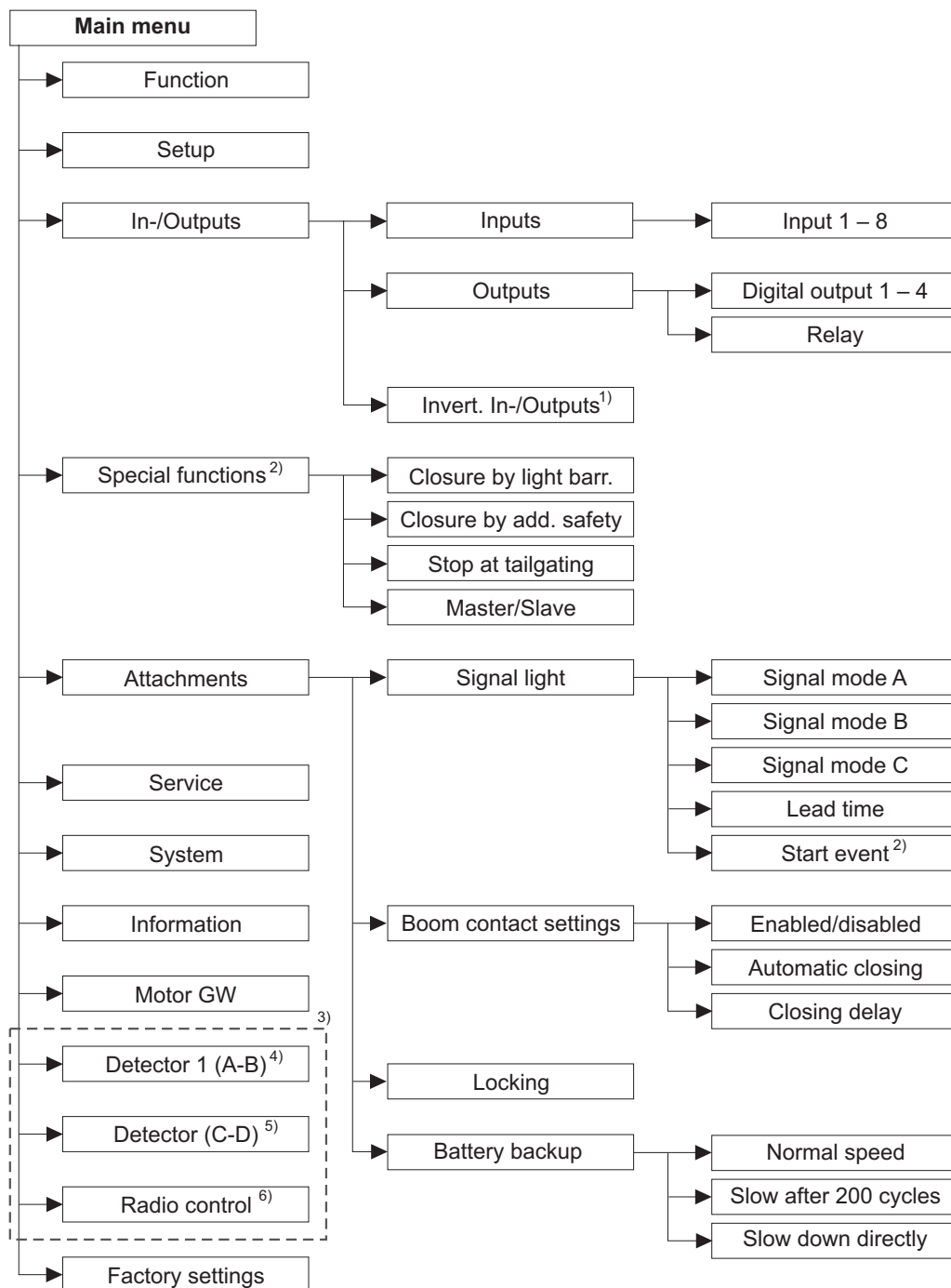
Menu setup

Mag00459b

Fig. 27: Main menu – Menus "In-/Outputs", "Special functions" and "Attachments"

- 1 Parameters can be set only for barriers with the "MGC-Pro" control unit and only after entering the service password.
- 2 Menu "Special functions" and parameters "Start event" only for the barriers "Access", "Parking" and "Toll"
- 3 The view depends on the plugged-in plug-in modules such as "Ethernet" or "RS485/422" and on whether a service module is connected.
- 4 Menu "Detector 1 (A-B)" in the first plug-in module "Detector"
- 5 Menu "Detector 2 (C-D)" only with a second plug-in module "Detector" (optional)
- 6 Menu "Radio control" only with optional plug-in module "Radio"

Menu setup

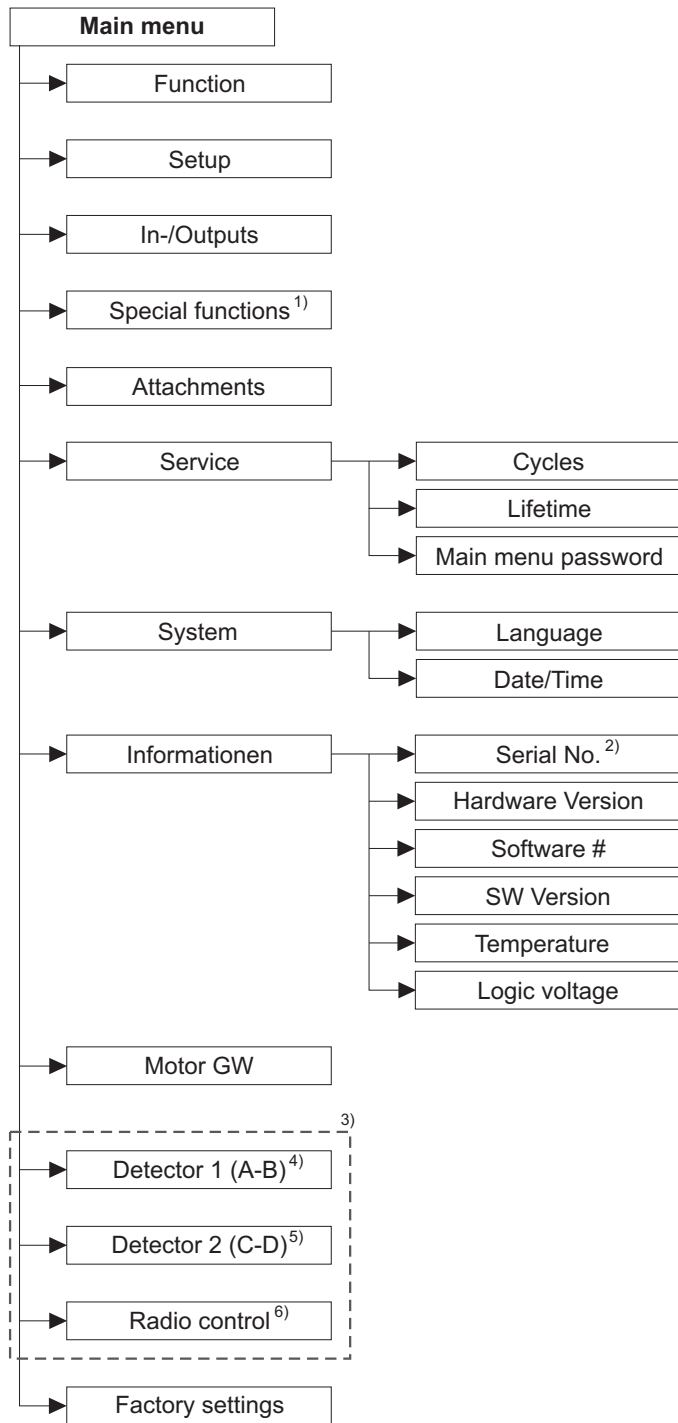

Mag00645

Fig. 28: Main menu – Menus "Service", "System", "Information" and "Motor GW"

- 1 Menu "Special functions" only for the barriers "Access", "Parking" and "Toll"
- 2 Parameter "Serial No." only for the barriers "Toll High Speed"
- 3 The view depends on the plugged-in plug-in modules such as "Ethernet" or "RS485/422" and on whether a service module is connected.
- 4 Menu "Detector 1 (A-B)" in the first plug-in module "Detector"
- 5 Menu "Detector 2 (C-D)" only with a second plug-in module "Detector" (optional)
- 6 Menu "Radio control" only with optional plug-in module "Radio"

Menu setup

Fig. 29: Main menu – Menus "Motor GW" and "Remote control"
See the following page for the menu "Detector".

- 1 Menu "Special functions" only for the barriers "Access", "Parking" and "Toll"
- 2 The view depends on the plugged-in plug-in modules such as "Ethernet" or "RS485/422" and on whether a service module is connected.
- 3 Menu "Detector 1 (A-B)" in the first plug-in module "Detector"
- 4 Menu "Detector 2 (C-D)" only with a second plug-in module "Detector" (optional)
- 5 Menu "Radio control" only with optional plug-in module "Radio"

Menu setup

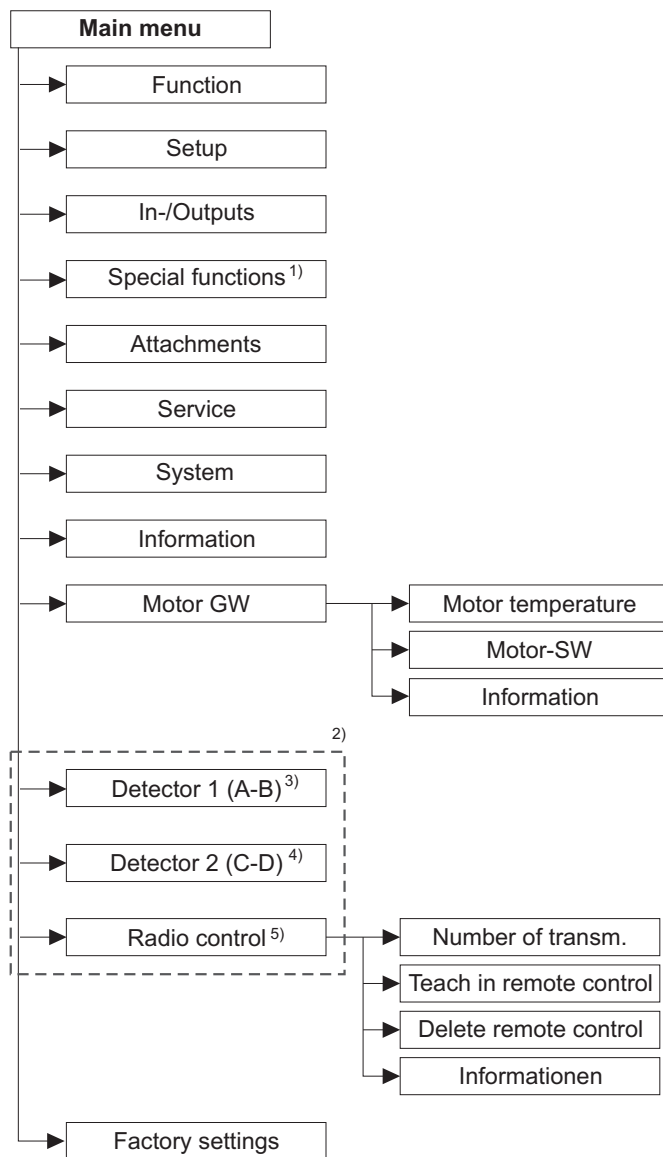
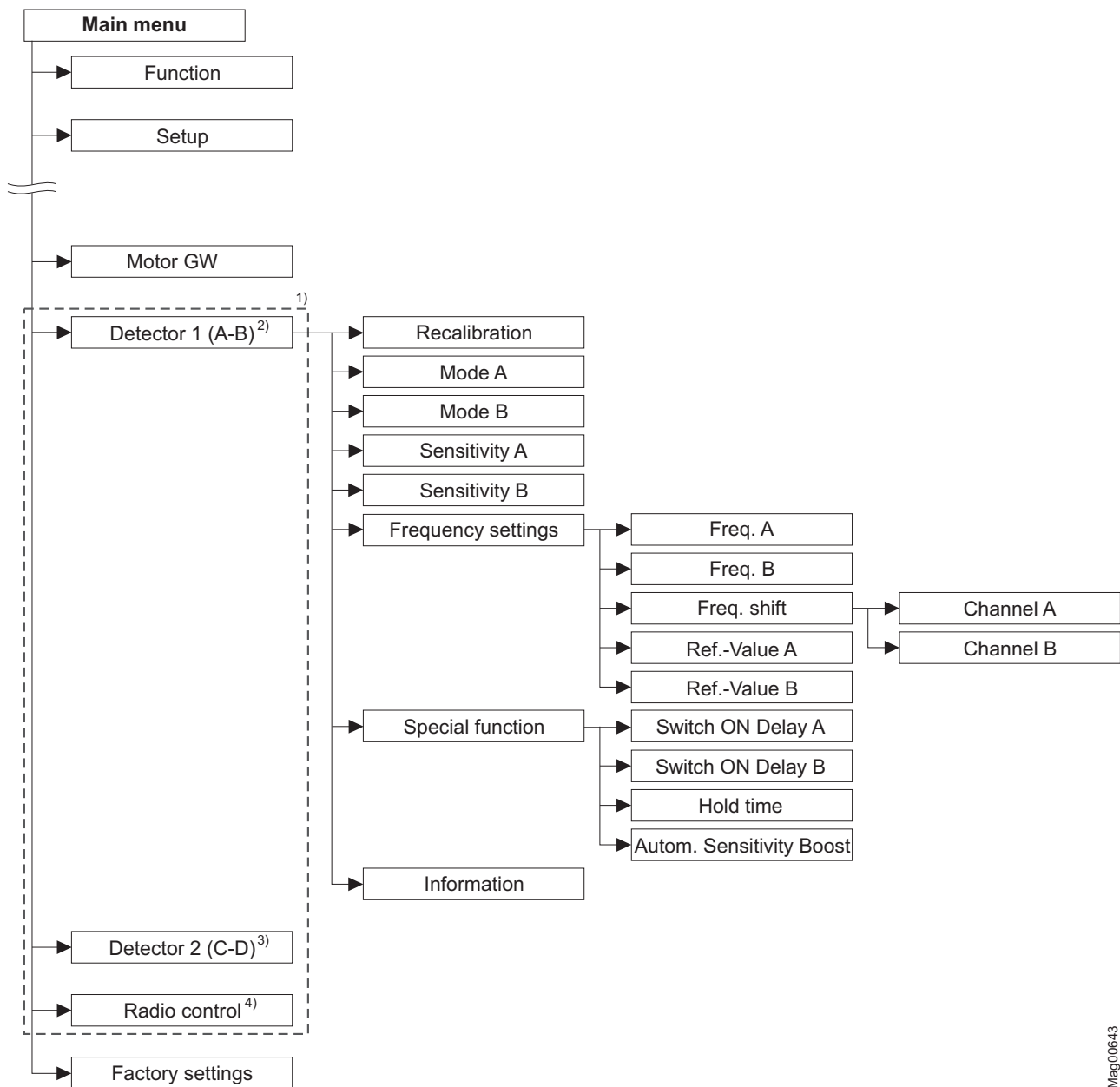

Mag00643

Fig. 30: Menus "Detector (A-B)"

- 1 The view depends on the plugged-in plug-in modules such as "Ethernet" or "RS485/422" and on whether a service module is connected.
- 2 Menu "Detector 1 (A-B)" in the first plug-in module "Detector"
- 3 Menu "Detector 2 (C-D)" only with a second plug-in module "Detector" (optional)
- 4 Menu "Radio control" only with optional plug-in module "Radio"

Index**1**

1. Parking zone full	
Output function.....	15

2

2. Parking zone full	
Output function.....	15

5

5 min perman. damping	
Output function.....	15

A

Acknowledgement	
Input function	11
Output function.....	14
Additional safety device	
Input function	11
Attachments	
Menu	66
Automatic closing	
Parameter	69
Automatic sensitivity boost	
Parameters	77

B

Barrier	
Manually close	44
Manually open.....	44
Barrier ready	
Output function.....	14
Barrier speed	
Menu	47
Battery backup	
Menu	72
Battery Backup	
Parameter	72
Battery operation	
Output function.....	18
Bistable.....	37
Blink signal light	
Input function	11
Boom angle	
Output function.....	13
Boom contact FB	
Output function.....	14
Boom contact input	
Input function	10
Boom contact settings	
Menu	69

C

Change value.....	26
Close	
Input function.....	10
Parameter	47
Close delay	
Parameter	48
Close direction	
Menu	46
Parameter	46
Close low priority	
Input function.....	10
Close Service	
Input function.....	11
Closed	
Output function.....	13
Closing	
Output function.....	13
Closing delay	
Parameter	70
Closure by add. safety	
Menu	64
Parameter	64
Closure by light barr.	
Menu	63
Control buttons	
Function	27
Control elements.....	25
Control unit	
Displays.....	25
Control unit control elements.....	25
Count open loop	
Parameter	50
Counter	
Parameter	50
Cut off angle	
Menu	49
Cycles	
Parameter	73

D

Date/time	
Parameter	74
Deadman	36
Delays	
Menu	47
Delete remote control	
Parameter	82
Detector 1 (A-B)	
Menu	75

Index

Detector 2 (C-D)		
Menu	81	
Digital inputs	8	
Digital outputs	12	
Direction 1 A => B		
Output function	17	
Direction 1 B => A		
Output function	17	
Direction 1 Pls A => B		
Output function	16	
Direction 1 Pls B => A		
Output function	16	
Direction 2 A => B		
Output function	18	
Direction 2 B => A		
Output function	18	
Direction 2 Pls A => B		
Output function	16	
Direction 2 Pls B => A		
Output function	17	
Disabled/Enabled		
Parameter	69	
Display		
Symbols	27	
Display contrast		
Setting	31	
Down		
Output function	15	
E		
Electrical specialists	6	
Entering password	23	
Error		
Output function	13	
Ext. impact detection		
Input function	10	
Ext. opening loop entry		
Input function	10	
Ext. opening loop exit		
Input function	10	
External		
Output function	19	
F		
Factory settings		
Reset	84	
Freq. A		
Parameter	76	
Freq. B		
Parameter	76	
Freq. shift		
Parameter	76	
Frequency setting		
Parameter	76	
Function		
Menu	46	
G		
General	5	
H		
Hardware version		
Parameter	74	
Hold time		
Parameters	77	
Hold-open time		
Parameter	47	
I		
Impact delay		
Parameter	48, 54	
Impact detection		
Output function	14	
Parameter	49	
Impact response		
Parameter	53	
Impact settings		
Menu	53	
In-/Outputs		
Menu	62	
Information		
Menu	45, 74	
Parameter	75, 76, 82	
Inhibit opening		
Input function	10	
Inhibit opening loop		
Input function	10	
Inhibit signal light		
Input function	10	
Input function		
Acknowledgement	11	
Additional safety device	11	
Blink signal light	11	
Boom contact input	10	
Close	10	
Close low priority	10	
Close Service	11	
Ext. impact detection	10	
Ext. opening loop entry	10	
Ext. opening loop exit	10	
Inhibit opening	10	
Inhibit opening loop	10	
Inhibit signal light	10	
Ope vend count	10	
Open high priority	9	

Open low priority	9	Mode A	
Open Service	11	Parameter	75
Opening exit	9	Mode B	
Parking counter reset	11	Parameter	75
Inputs		Module-Close	
Menu	62	Output function	19
Inputs (Menu)	See Digital inputs	Module-Open	
Inputs inverted	62	Output function	19
Inverted In-/Outputs		Module-Open prior	
Menu	62	Output function	18
L		Motor GW	
Language		Menu	75
Parameter	74	Motor temperature	
Lead time		Parameter	75
Parameter	68	N	
Lifetime		Number hand transm.	
Parameter	73	Parameter	82
Light barrier		O	
Parameter	49	Open	
Light barrier delay		Output function	13
Parameter	48	Parameter	47
Light barrier occupied		Open high priority	
Output function	18	Input function	9
Locking		Open low priority	
Menu	71	Input function	9
Output function	14	Open Service	
Parameter	71	Input function	11
Logic voltage		Open vend count	
Parameter	74	Input function	10
Loop active A		Open/Closed button	38
Output function	15	Opening	
Loop active B		Output function	13
Output function	15	Opening exit	
Loop active pulse A		Input function	9
Output function	15	Operational view	25
Loop active pulse B		Output function	
Output function	15	1st Parking zone full	15
Loop inactive pulse A		2nd Parking zone full	15
Output function	15	5 min perman. damping	15
Loop inactive pulse B		Acknowledgement	14
Output function	15	Barrier ready	14
M		Battery operation	18
Main menu password	31	Boom angle	13
Parameter	73	Boom contact FB	14
Maintained contact	36	Closed	13
Master	65	Closing	13
Master/Slave		Direction 1 A => B	17
Menu	65	Direction 1 B => A	17
Menu language	20	Direction 1 Pls A => B	16
Menu setup	87	Direction 1 Pls B => A	16
MHTM™ MicroDrive service expert	6	Direction 2 A => B	18

Index

Direction 2 B => A 18
 Direction 2 Pls A => B 16
 Direction 2 Pls B => A 17
 Down 15
 Error 13
 External 19
 Impact detection 14
 Light barrier occupied 18
 Locking 14
 Loop active A 15
 Loop active B 15
 Loop active pulse A 15
 Loop active pulse B 15
 Loop inactive pulse A 15
 Loop inactive pulse B 15
 Module-Close 19
 Module-Open 19
 Module-Open prior 18
 Open 13
 Opening 13
 Parallel operation 14
 Pulse after passage 13
 Safety active 14
 Service mode active 14
 Signal light A 14
 Signal light B 14
 Signal light C 14
 Sliding door pulse 13
 Tailgating 13
 Up 15
 Warning 13
 Output relay 12
 Outputs
 Menu 62
 Outputs (Menu) See Digital outputs
 Outputs inverted 62

P

Parallel operation 65
 Output function 14
 Parameterization
 Protection from access 31
 Parameterizing
 Options 32
 Values 33
 Parking counter reset
 Input function 11
 Password protection 31
 Pictogram explanation 5
 Power failure
 Menu 61
 Parameter 61
 Prog. mode See Program mode

Program mode
 Deadman 36
 Maintained contact 36
 Menu 46
 Pulse control 37
 Select 32
 Setup 47
 Two-pulse control 38
 PSU-FB
 Parameter 74
 Pulse after passage
 Output function 13
 Pulse control 37

R

Radio control FM
 Menu 81
 Recalibration
 Parameter 75
 Ref. Val. A
 Parameter 76
 Ref. Val. B
 Parameter 76
 Reset behaviour
 Parameter 50
 Restart 54

S

Safety active
 Output function 14
 Safety loop close
 Parameter 49
 Safety loop close
 Parameter 49
 Select program mode 34, 35
 Sensitivity
 Parameter 54
 Sensitivity A
 Parameter 75
 Sensitivity B
 Parameter 76
 Serial no
 Parameter 74
 Service
 Menu 73
 Mode 44
 Switch off Mode 44
 Switch on Mode 44
 Service mode active
 Output function 14
 Service switch 44
 Setup
 Program mode 34, 35

Signal light		
Menu	66	
Signal light A		
Output function.....	14	
Signal light B		
Output function.....	14	
Signal light C		
Output function.....	14	
Signal mode A		
Parameter	66	
Signal mode B		
Parameter	67	
Signal mode C		
Parameter	67	
Slave.....	65	
Sliding door pulse		
Output function.....	13	
Software #		
Parameter	74	
Special functions		
Parameter	76	
Special functions		
Menu	63	
Specialists		
Requirements.....	6	
Start event		
Parameter	68	
Start-up behav.		
Parameter	55, 56	
Start-up settings		
Menu	55	
Stay closed		
Parameter	55	
Stop at tailgating		
Menu	64	
Parameter	64	
SW Version		
Parameter	74, 75	
Switch ON Delay A		
Parameters.....	77	
Switch ON Delay B		
Parameters.....	77	
Symbols		
Control button functions	27	
Current program mode.....	30	
Current state of the barrier.....	28, 29	
Current state of the induction loops	30	
Further.....	30	
System		
Menu	74	
T		
Tailgating		
Output function.....	13	
Teach in remote control		
Parameter	82	
Temperature		
Parameter	74	
Two-pulse control	38	
U		
Up		
Output function.....	15	
V		
Vend Count		
Menu	50	
W		
Warning		
Output function.....	13	
Warning notes.....	5	
X		
X20-EN		
Parameter	74	