

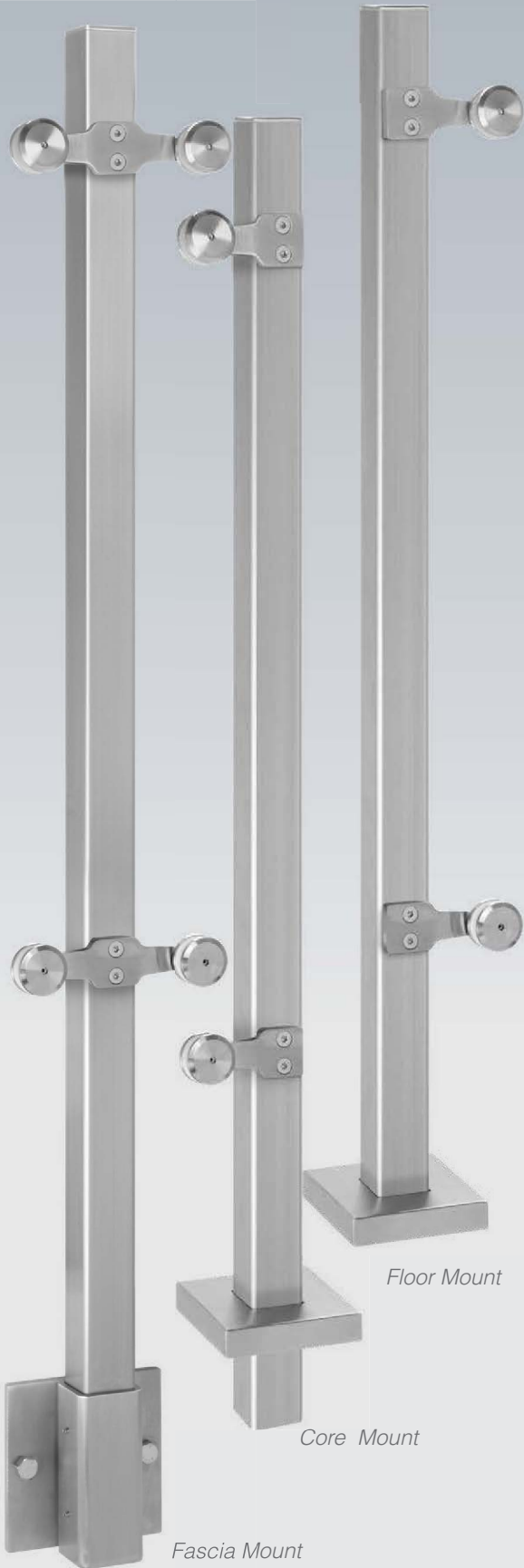

Square Post Glass Railing





GLASS-SPIDER RAILING SYSTEM

Hurricane-strength, marine-grade railing posts are prefabricated to make installation a breeze.

The modern look of our 316-grade stainless steel glass-spider railing system is ideal for both indoor and outdoor applications. Heavy-duty posts have been certified for wind loads up to ± 3.5 [KPa] which is what is experienced in a Level 5 Hurricane. Our prefabricated glass-spider system is an attractive, low maintenance, and easy-to-install railing option for residential or commercial applications. It is extremely durable and allows for beautiful, unimpaired views. Available in 2" square with choice of mount style. All work with glass infill that is 1/2" to 3/4" thick.



FLOOR MOUNT POSTS FOR GLASS/SPIDER, 2"



PART	POST HEIGHT	POST DIA.	MOUNT	POSITION	FINISH	DIM A	DIM B	DIM C
GS/S2/EN/42/EC/FL/RT	42"	2"	Floor	Right End	Satin	28.5"	42.0"	46.0"
GS/S2/EN/42/EC/FL/LT	42"	2"	Floor	Left End	Satin	28.5"	42.0"	46.0"
GS/S2/CN/42/EC/FL	42"	2"	Floor	Center	Satin	28.5"	42.0"	46.0"
GS/S2/CR/42/EC/FL	42"	2"	Floor	Corner	Satin	28.5"	42.0"	46.0"

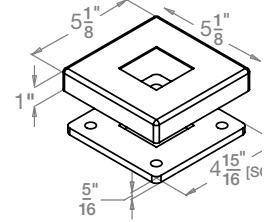

FASCIA MOUNT POSTS FOR GLASS/SPIDER, 2"



PART	POST HEIGHT	POST DIA.	MOUNT	POSITION	FINISH	DIM A	DIM B	DIM C
GS/S2/EN/42/EC/FM/RT	42"	2"	Fascia	Right End	Satin	28.5"	42.0"	46.0"
GS/S2/EN/42/EC/FM/LT	42"	2"	Fascia	Left End	Satin	28.5"	42.0"	46.0"
GS/S2/CN/42/EC/FM	42"	2"	Fascia	Center	Satin	28.5"	42.0"	46.0"

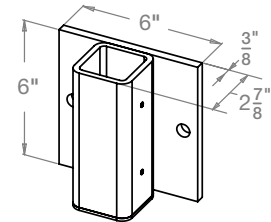

CORE DRILL POSTS FOR GLASS/SPIDER, 2"



PART	POST HEIGHT	POST DIA.	MOUNT	POSITION	FINISH	DIM A	DIM B	DIM C
GS/S2/EN/42/EC/CD/RT	42"	2"	Core Drill	Right End	Satin	28.5"	42.0"	46.0"
GS/S2/EN/42/EC/CD/LT	42"	2"	Core Drill	Left End	Satin	28.5"	42.0"	46.0"
GS/S2/CN/42/EC/CD	42"	2"	Core Drill	Center	Satin	28.5"	42.0"	46.0"
GS/S2/CR/42/EC/CD	42"	2"	Core Drill	Corner	Satin	28.5"	42.0"	46.0"

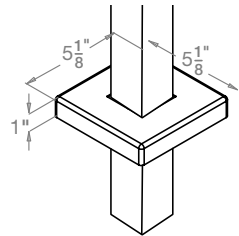

42-inch Post

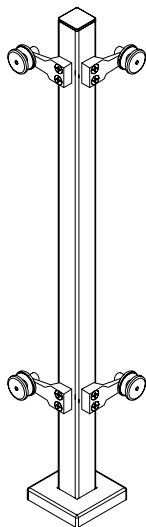

Floor Mount, Corner

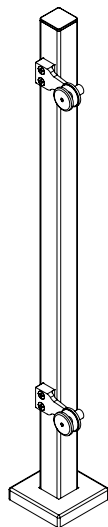

Floor Mount, End

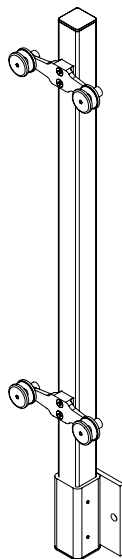

Fascia Mount, Center

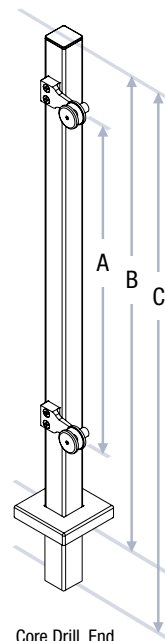

Core Drill, End

GLASS GRIP RAILING SYSTEM

The look of custom, the ease of Prefab.

The pure beauty of 316 stainless steel prefabricated railing posts is matched only by the effortless installation. You'll appreciate the attention to detail that makes every part fit together perfectly. Our prefabricated Square Railing Posts with Glass Grips offer a modern aesthetic, and are attractive, low maintenance, and allow for quick and easy installation saving you time and money. Available in 1.5" or 2" square tubing, each can accommodate a glass infill that is $\frac{3}{8}$ " to $\frac{1}{2}$ " thick.



Saddle Options



Adjustable Saddle
for 1.67" Tubing



Fixed Saddle
for 1.67" Tubing



Adjustable Saddle
for Flat Tubing



Fixed Saddle
for Flat Tubing

Our Glass Clip Posts are available for both 1/2" and 3/8" thick glass.

All mounting hardware included.

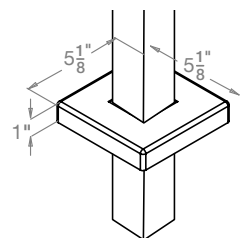
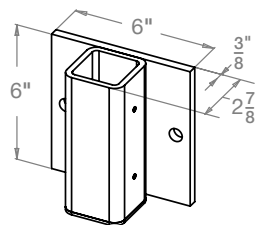
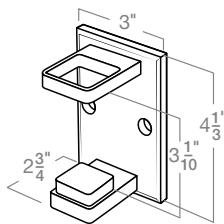
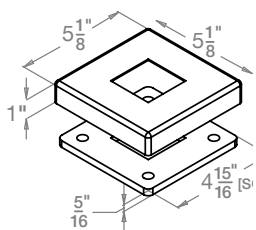
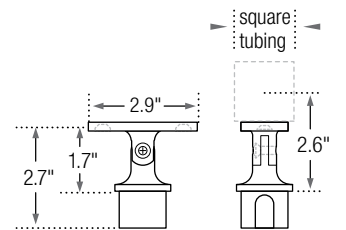
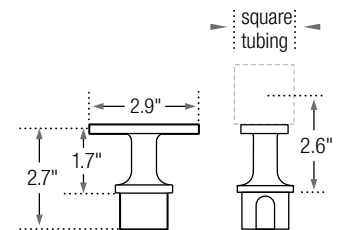
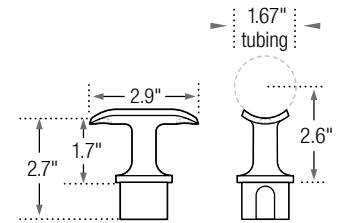
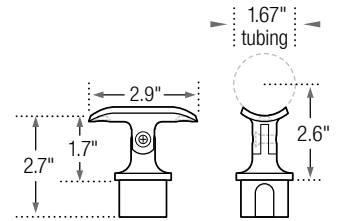

Glass Grip Railing, 1.5" Posts

FLOOR MOUNT POSTS, 1.5"

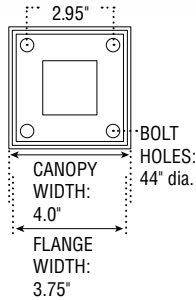

POST DIA.	POST HEIGHT	SADDLE	POSITION	FINISH	DIM A	DIM B	DIM C	PART
36" Handrail								
1.5"	36"	Adj. Round	End	Satin	36.2"	N/A	N/A	GC/SH/EN/36/AR/FL
1.5"	36"	Adj. Flat	End	Satin	36.2"	N/A	N/A	GC/SH/EN/36/AF/FL
1.5"	36"	Fixed Round	End	Satin	36.2"	N/A	N/A	GC/SH/EN/36/FR/FL
1.5"	36"	Fixed Flat	End	Satin	36.2"	N/A	N/A	GC/SH/EN/36/FF/FL
1.5"	36"	End Cap	End	Satin	36.2"	N/A	N/A	GC/SH/EN/36/EC/FL
1.5"	36"	Adj. Round	Center	Satin	36.2"	N/A	N/A	GC/SH/CN/36/AR/FL
1.5"	36"	Adj. Flat	Center	Satin	36.2"	N/A	N/A	GC/SH/CN/36/AF/FL
1.5"	36"	Fixed Round	Center	Satin	36.2"	N/A	N/A	GC/SH/CN/36/FR/FL
1.5"	36"	Fixed Flat	Center	Satin	36.2"	N/A	N/A	GC/SH/CN/36/FF/FL
1.5"	36"	End Cap	Center	Satin	36.2"	N/A	N/A	GC/SH/CN/36/EC/FL
1.5"	36"	Fixed Round	Corner	Satin	36.2"	N/A	N/A	GC/SH/CR/36/FR/FL
1.5"	36"	Fixed Flat	Corner	Satin	36.2"	N/A	N/A	GC/SH/CR/36/FF/FL
1.5"	36"	End Cap	Corner	Satin	36.2"	N/A	N/A	GC/SH/CR/36/EC/FL
42" Guardrail								
1.5"	42"	Adj. Round	End	Satin	42.2"	N/A	N/A	GC/SH/EN/42/AR/FL
1.5"	42"	Adj. Flat	End	Satin	42.2"	N/A	N/A	GC/SH/EN/42/AF/FL
1.5"	42"	Fixed Round	End	Satin	42.2"	N/A	N/A	GC/SH/EN/42/FR/FL
1.5"	42"	Fixed Flat	End	Satin	42.2"	N/A	N/A	GC/SH/EN/42/FF/FL
1.5"	42"	End Cap	End	Satin	42.2"	N/A	N/A	GC/SH/EN/42/EC/FL
1.5"	42"	Adj. Round	Center	Satin	42.2"	N/A	N/A	GC/SH/CN/42/AR/FL
1.5"	42"	Adj. Flat	Center	Satin	42.2"	N/A	N/A	GC/SH/CN/42/AF/FL
1.5"	42"	Fixed Round	Center	Satin	42.2"	N/A	N/A	GC/SH/CN/42/FR/FL
1.5"	42"	Fixed Flat	Center	Satin	42.2"	N/A	N/A	GC/SH/CN/42/FF/FL
1.5"	42"	End Cap	Center	Satin	42.2"	N/A	N/A	GC/SH/CN/42/EC/FL
1.5"	42"	Fixed Round	Corner	Satin	42.2"	N/A	N/A	GC/SH/CR/42/FR/FL
1.5"	42"	Fixed Flat	Corner	Satin	42.2"	N/A	N/A	GC/SH/CR/42/FF/FL
1.5"	42"	End Cap	Corner	Satin	42.2"	N/A	N/A	GC/SH/CR/42/EC/FL

1.5" FLOOR MOUNT POSTS

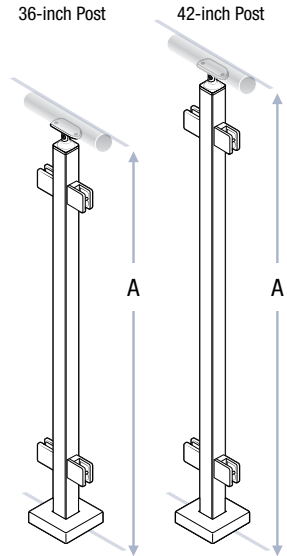

FASCIA MOUNT POSTS, 1.5"

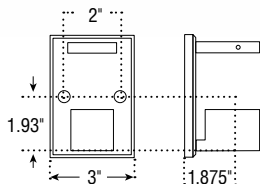

POST DIA.	POST HEIGHT	SADDLE	POSITION	FINISH	DIM A	DIM B	DIM C	PART
36" Handrail								
1.5"	36"	Adj. Round	End	Satin	42.7"	36.2"	6.5"	GC/SH/EN/36/AR/FM
1.5"	36"	Adj. Flat	End	Satin	42.7"	36.2"	6.5"	GC/SH/EN/36/AF/FM
1.5"	36"	Fixed Round	End	Satin	42.7"	36.2"	6.5"	GC/SH/EN/36/FR/FM
1.5"	36"	Fixed Flat	End	Satin	42.7"	36.2"	6.5"	GC/SH/EN/36/FF/FM
1.5"	36"	End Cap	End	Satin	42.7"	36.2"	6.5"	GC/SH/EN/36/EC/FM
1.5"	36"	Adj. Round	Center	Satin	42.7"	36.2"	6.5"	GC/SH/CN/36/AR/FM
1.5"	36"	Adj. Flat	Center	Satin	42.7"	36.2"	6.5"	GC/SH/CN/36/AF/FM
1.5"	36"	Fixed Round	Center	Satin	42.7"	36.2"	6.5"	GC/SH/CN/36/FR/FM
1.5"	36"	Fixed Flat	Center	Satin	42.7"	36.2"	6.5"	GC/SH/CN/36/FF/FM
1.5"	36"	End Cap	Center	Satin	42.7"	36.2"	6.5"	GC/SH/CN/36/EC/FM
42" Guardrail								
1.5"	42"	Adj. Round	End	Satin	48.7"	42.2"	6.5"	GC/SH/EN/42/AR/FM
1.5"	42"	Adj. Flat	End	Satin	48.7"	42.2"	6.5"	GC/SH/EN/42/AF/FM
1.5"	42"	Fixed Round	End	Satin	48.7"	42.2"	6.5"	GC/SH/EN/42/FR/FM
1.5"	42"	Fixed Flat	End	Satin	48.7"	42.2"	6.5"	GC/SH/EN/42/FF/FM
1.5"	42"	End Cap	End	Satin	48.7"	42.2"	6.5"	GC/SH/EN/42/EC/FM
1.5"	42"	Adj. Round	Center	Satin	48.7"	42.2"	6.5"	GC/SH/CN/42/AR/FM
1.5"	42"	Adj. Flat	Center	Satin	48.7"	42.2"	6.5"	GC/SH/CN/42/AF/FM
1.5"	42"	Fixed Round	Center	Satin	48.7"	42.2"	6.5"	GC/SH/CN/42/FR/FM
1.5"	42"	Fixed Flat	Center	Satin	48.7"	42.2"	6.5"	GC/SH/CN/42/FF/FM
1.5"	42"	End Cap	Center	Satin	48.7"	42.2"	6.5"	GC/SH/CN/42/EC/FM

1.5" FASCIA MOUNT GLASS GRIP POSTS

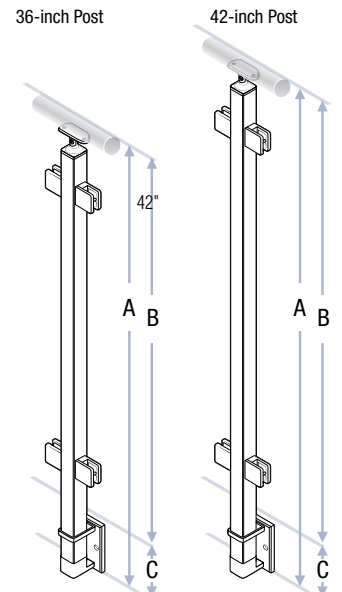

CORE DRILL POSTS, 1.5"

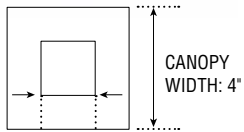

INSIDE WIDTH: 1.5"
(accommodates
1.5" square tubing)

CANOPY
WIDTH: 4"

POST DIA.	POST HEIGHT	SADDLE	POSITION	FINISH	DIM A	DIM B	DIM C	PART
36" Handrail								
1.5"	36"	Adj. Round	End	Satin	40.2"	36.2"	4.0"	GC/SH/EN/36/AR/CD
1.5"	36"	Adj. Flat	End	Satin	40.2"	36.2"	4.0"	GC/SH/EN/36/AF/CD
1.5"	36"	Fixed Round	End	Satin	40.2"	36.2"	4.0"	GC/SH/EN/36/FR/CD
1.5"	36"	Fixed Flat	End	Satin	40.2"	36.2"	4.0"	GC/SH/EN/36/FF/CD
1.5"	36"	End Cap	End	Satin	40.2"	36.2"	4.0"	GC/SH/EN/36/EC/CD
1.5"	36"	Adj. Round	Center	Satin	40.2"	36.2"	4.0"	GC/SH/CN/36/AR/CD
1.5"	36"	Adj. Flat	Center	Satin	40.2"	36.2"	4.0"	GC/SH/CN/36/AF/CD
1.5"	36"	Fixed Round	Center	Satin	40.2"	36.2"	4.0"	GC/SH/CN/36/FR/CD
1.5"	36"	Fixed Flat	Center	Satin	40.2"	36.2"	4.0"	GC/SH/CN/36/FF/CD
1.5"	36"	End Cap	Center	Satin	40.2"	36.2"	4.0"	GC/SH/CN/36/EC/CD
1.5"	36"	Fixed Round	Corner	Satin	40.2"	36.2"	4.0"	GC/SH/CR/36/FR/CD
1.5"	36"	Fixed Flat	Corner	Satin	40.2"	36.2"	4.0"	GC/SH/CR/36/FF/CD
1.5"	36"	End Cap	Corner	Satin	40.2"	36.2"	4.0"	GC/SH/CR/36/EC/CD
42" Guardrail								
1.5"	42"	Adj. Round	End	Satin	46.2"	42.2"	4.0"	GC/SH/EN/42/AR/CD
1.5"	42"	Adj. Flat	End	Satin	46.2"	42.2"	4.0"	GC/SH/EN/42/AF/CD
1.5"	42"	Fixed Round	End	Satin	46.2"	42.2"	4.0"	GC/SH/EN/42/FR/CD
1.5"	42"	Fixed Flat	End	Satin	46.2"	42.2"	4.0"	GC/SH/EN/42/FF/CD
1.5"	42"	End Cap	End	Satin	46.2"	42.2"	4.0"	GC/SH/EN/42/EC/CD
1.5"	42"	Adj. Round	Center	Satin	46.2"	42.2"	4.0"	GC/SH/CN/42/AR/CD
1.5"	42"	Adj. Flat	Center	Satin	46.2"	42.2"	4.0"	GC/SH/CN/42/AF/CD
1.5"	42"	Fixed Round	Center	Satin	46.2"	42.2"	4.0"	GC/SH/CN/42/FR/CD
1.5"	42"	Fixed Flat	Center	Satin	46.2"	42.2"	4.0"	GC/SH/CN/42/FF/CD
1.5"	42"	End Cap	Center	Satin	46.2"	42.2"	4.0"	GC/SH/CN/42/EC/CD
1.5"	42"	Fixed Round	Corner	Satin	46.2"	42.2"	4.0"	GC/SH/CR/42/FR/CD
1.5"	42"	Fixed Flat	Corner	Satin	46.2"	42.2"	4.0"	GC/SH/CR/42/FF/CD
1.5"	42"	End Cap	Corner	Satin	46.2"	42.2"	4.0"	GC/SH/CR/42/EC/CD

1.5" CORE DRILL POSTS

36-inch Post

42-inch Post

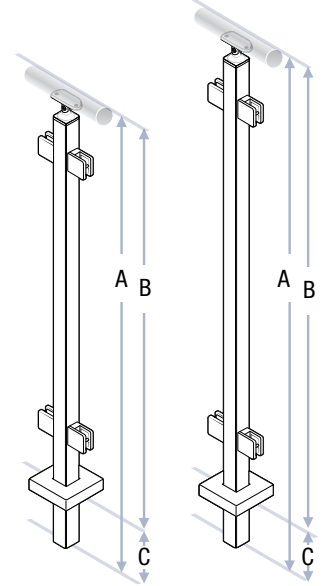

Glass Grip Railing, 2" Posts

FLOOR MOUNT POSTS, 2"

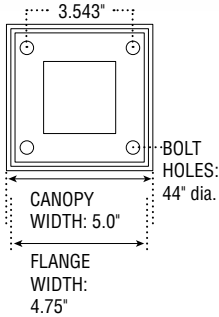

POST DIA.	POST HEIGHT	SADDLE	POSITION	FINISH	DIM A	DIM B	DIM C	PART
36" Handrail								
2"	36"	Adj. Round	End	Satin	36.2"	N/A	N/A	GC/S2/EN/36/AR/FL
2"	36"	Adj. Flat	End	Satin	36.2"	N/A	N/A	GC/S2/EN/36/AF/FL
2"	36"	Fixed Round	End	Satin	36.2"	N/A	N/A	GC/S2/EN/36/FR/FL
2"	36"	Fixed Flat	End	Satin	36.2"	N/A	N/A	GC/S2/EN/36/FF/FL
2"	36"	End Cap	End	Satin	36.2"	N/A	N/A	GC/S2/EN/36/EC/FL
2"	36"	Adj. Round	Center	Satin	36.2"	N/A	N/A	GC/S2/CN/36/AR/FL
2"	36"	Adj. Flat	Center	Satin	36.2"	N/A	N/A	GC/S2/CN/36/AF/FL
2"	36"	Fixed Round	Center	Satin	36.2"	N/A	N/A	GC/S2/CN/36/FR/FL
2"	36"	Fixed Flat	Center	Satin	36.2"	N/A	N/A	GC/S2/CN/36/FF/FL
2"	36"	End Cap	Center	Satin	36.2"	N/A	N/A	GC/S2/CN/36/EC/FL
2"	36"	Fixed Round	Corner	Satin	36.2"	N/A	N/A	GC/S2/CR/36/FR/FL
2"	36"	Fixed Flat	Corner	Satin	36.2"	N/A	N/A	GC/S2/CR/36/FF/FL
2"	36"	End Cap	Corner	Satin	36.2"	N/A	N/A	GC/S2/CR/36/EC/FL
42" Guardrail								
2"	42"	Adj. Round	End	Satin	42.2"	N/A	N/A	GC/S2/EN/42/AR/FL
2"	42"	Adj. Flat	End	Satin	42.2"	N/A	N/A	GC/S2/EN/42/AF/FL
2"	42"	Fixed Round	End	Satin	42.2"	N/A	N/A	GC/S2/EN/42/FR/FL
2"	42"	Fixed Flat	End	Satin	42.2"	N/A	N/A	GC/S2/EN/42/FF/FL
2"	42"	End Cap	End	Satin	42.2"	N/A	N/A	GC/S2/EN/42/EC/FL
2"	42"	Adj. Round	Center	Satin	42.2"	N/A	N/A	GC/S2/CN/42/AR/FL
2"	42"	Adj. Flat	Center	Satin	42.2"	N/A	N/A	GC/S2/CN/42/AF/FL
2"	42"	Fixed Round	Center	Satin	42.2"	N/A	N/A	GC/S2/CN/42/FR/FL
2"	42"	Fixed Flat	Center	Satin	42.2"	N/A	N/A	GC/S2/CN/42/FF/FL
2"	42"	End Cap	Center	Satin	42.2"	N/A	N/A	GC/S2/CN/42/EC/FL
2"	42"	Fixed Round	Corner	Satin	42.2"	N/A	N/A	GC/S2/CR/42/FR/FL
2"	42"	Fixed Flat	Corner	Satin	42.2"	N/A	N/A	GC/S2/CR/42/FF/FL
2"	42"	End Cap	Corner	Satin	42.2"	N/A	N/A	GC/S2/CR/42/EC/FL

2" FLOOR MOUNT POSTS

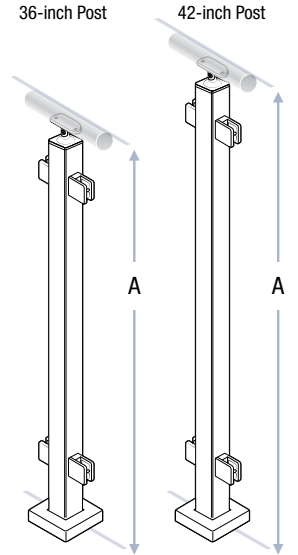

FASCIA MOUNT POSTS, 1.5"

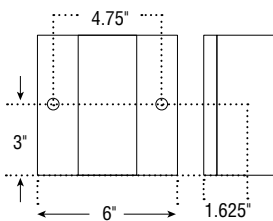

POST DIA.	POST HEIGHT	SADDLE	POSITION	FINISH	DIM A	DIM B	DIM C	PART
36" Handrail								
2"	36"	Adj. Round	End	Satin	42.7"	36.2"	6.5"	GC/S2/EN/36/AR/FM
2"	36"	Adj. Flat	End	Satin	42.7"	36.2"	6.5"	GC/S2/EN/36/AF/FM
2"	36"	Fixed Round	End	Satin	42.7"	36.2"	6.5"	GC/S2/EN/36/FR/FM
2"	36"	Fixed Flat	End	Satin	42.7"	36.2"	6.5"	GC/S2/EN/36/FF/FM
2"	36"	End Cap	End	Satin	42.7"	36.2"	6.5"	GC/S2/EN/36/EC/FM
2"	36"	Adj. Round	Center	Satin	42.7"	36.2"	6.5"	GC/S2/CN/36/AR/FM
2"	36"	Adj. Flat	Center	Satin	42.7"	36.2"	6.5"	GC/S2/CN/36/AF/FM
2"	36"	Fixed Round	Center	Satin	42.7"	36.2"	6.5"	GC/S2/CN/36/FR/FM
2"	36"	Fixed Flat	Center	Satin	42.7"	36.2"	6.5"	GC/S2/CN/36/FF/FM
2"	36"	End Cap	Center	Satin	42.7"	36.2"	6.5"	GC/S2/CN/36/EC/FM
42" Guardrail								
2"	42"	Adj. Round	End	Satin	48.7"	42.2"	6.5"	GC/S2/EN/42/AR/FM
2"	42"	Adj. Flat	End	Satin	48.7"	42.2"	6.5"	GC/S2/EN/42/AF/FM
2"	42"	Fixed Round	End	Satin	48.7"	42.2"	6.5"	GC/S2/EN/42/FR/FM
2"	42"	Fixed Flat	End	Satin	48.7"	42.2"	6.5"	GC/S2/EN/42/FF/FM
2"	36"	End Cap	End	Satin	48.7"	42.2"	6.5"	GC/S2/EN/42/EC/FM
2"	42"	Adj. Round	Center	Satin	48.7"	42.2"	6.5"	GC/S2/CN/42/AR/FM
2"	42"	Adj. Flat	Center	Satin	48.7"	42.2"	6.5"	GC/S2/CN/42/AF/FM
2"	42"	Fixed Round	Center	Satin	48.7"	42.2"	6.5"	GC/S2/CN/42/FR/FM
2"	42"	Fixed Flat	Center	Satin	48.7"	42.2"	6.5"	GC/S2/CN/42/FF/FM
2"	42"	End Cap	Center	Satin	48.7"	42.2"	6.5"	GC/S2/CN/42/EC/FM

2" FASCIA MOUNT GLASS GRIP POSTS

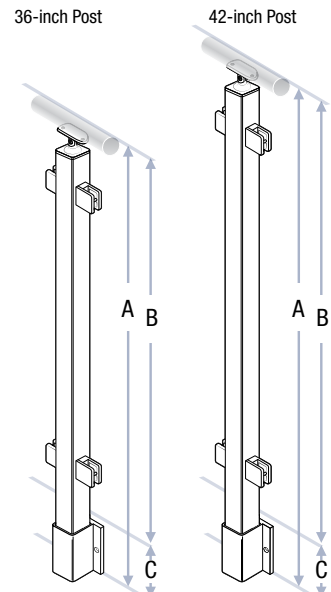

CORE DRILL POSTS, 2"

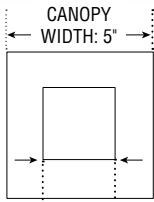

INSIDE WIDTH: 2"
(accommodates
2" square tubing)

POST DIA.	POST HEIGHT	SADDLE	POSITION	FINISH	DIM A	DIM B	DIM C	PART
36" Handrail								
2"	36"	Adj. Round	End	Satin	40.2"	36.2"	4.0"	GC/S2/EN/36/AR/CD
2"	36"	Adj. Flat	End	Satin	40.2"	36.2"	4.0"	GC/S2/EN/36/AF/CD
2"	36"	Fixed Round	End	Satin	40.2"	36.2"	4.0"	GC/S2/EN/36/FR/CD
2"	36"	Fixed Flat	End	Satin	40.2"	36.2"	4.0"	GC/S2/EN/36/FF/CD
2"	36"	End Cap	End	Satin	40.2"	36.2"	4.0"	GC/S2/EN/36/EC/CD
2"	36"	Adj. Round	Center	Satin	40.2"	36.2"	4.0"	GC/S2/CN/36/AR/CD
2"	36"	Adj. Flat	Center	Satin	40.2"	36.2"	4.0"	GC/S2/CN/36/AF/CD
2"	36"	Fixed Round	Center	Satin	40.2"	36.2"	4.0"	GC/S2/CN/36/FR/CD
2"	36"	Fixed Flat	Center	Satin	40.2"	36.2"	4.0"	GC/S2/CN/36/FF/CD
2"	36"	End Cap	Center	Satin	40.2"	36.2"	4.0"	GC/S2/CN/36/EC/CD
2"	36"	Fixed Round	Corner	Satin	40.2"	36.2"	4.0"	GC/S2/CR/36/FR/CD
2"	36"	Fixed Flat	Corner	Satin	40.2"	36.2"	4.0"	GC/S2/CR/36/FF/CD
2"	36"	End Cap	Corner	Satin	40.2"	36.2"	4.0"	GC/S2/CR/36/EC/CD
42" Guardrail								
2"	42"	Adj. Round	End	Satin	46.2"	42.2"	4.0"	GC/S2/EN/42/AR/CD
2"	42"	Adj. Flat	End	Satin	46.2"	42.2"	4.0"	GC/S2/EN/42/AF/CD
2"	42"	Fixed Round	End	Satin	46.2"	42.2"	4.0"	GC/S2/EN/42/FR/CD
2"	42"	Fixed Flat	End	Satin	46.2"	42.2"	4.0"	GC/S2/EN/42/FF/CD
2"	42"	End Cap	End	Satin	46.2"	42.2"	4.0"	GC/S2/EN/42/EC/CD
2"	42"	Adj. Round	Center	Satin	46.2"	42.2"	4.0"	GC/S2/CN/42/AR/CD
2"	42"	Adj. Flat	Center	Satin	46.2"	42.2"	4.0"	GC/S2/CN/42/AF/CD
2"	42"	Fixed Round	Center	Satin	46.2"	42.2"	4.0"	GC/S2/CN/42/FR/CD
2"	42"	Fixed Flat	Center	Satin	46.2"	42.2"	4.0"	GC/S2/CN/42/FF/CD
2"	42"	End Cap	Center	Satin	46.2"	42.2"	4.0"	GC/S2/CN/42/EC/CD
2"	42"	Fixed Round	Corner	Satin	46.2"	42.2"	4.0"	GC/S2/CR/42/FR/CD
2"	42"	Fixed Flat	Corner	Satin	46.2"	42.2"	4.0"	GC/S2/CR/42/FF/CD
2"	42"	End Cap	Corner	Satin	46.2"	42.2"	4.0"	GC/S2/CR/42/EC/CD

2" CORE DRILL POSTS

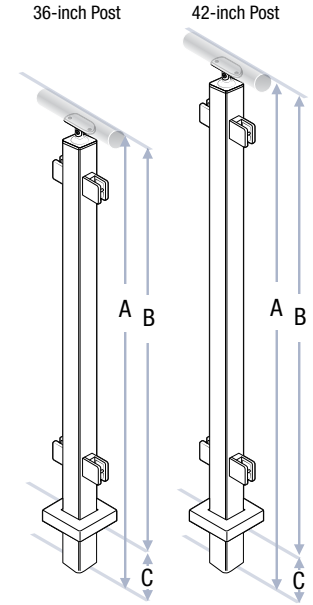

RAILING COMPONENTS



Components allow for customization within a railing project to connect or finish tubing that may present challenges in tighter areas. Our components are designed to work seamlessly with our prefabricated posts and tubing, just double-check that the diameter and wall thickness match. We offer a variety of styles to ensure to a cohesive look to your railing project.

Square Adjustable Handrail Saddle, 1.67"



Connects a square post to a round 1.67" top rail. Adjustable saddle is for stair applications.

SQ. TUBE DIAMETER	TUBE THICKNESS	TOP RAIL	PART NUMBER
1.5"	.125"	1.5 or 1.67"	49-352ASQ/1H
2"	.125"	2"	49-352ASQ/2

Square Fixed Handrail Saddle, 1.67"



Connects a square post to a round 1.67" top rail. Fixed saddle is perfect for center posts.

SQ. TUBE DIAMETER	TUBE THICKNESS	TOP RAIL	PART NUMBER
1.5"	.125"	1.5 or 1.67"	49-352SQ/1H
2"	.125"	2"	49-352SQ/2

Square Handrail Corner Saddle, 1.67"



Square post corner connection for two mitered round 1.67" top rails.

SQ. TUBE DIAMETER	TUBE THICKNESS	TOP RAIL	PART NUMBER
1.5"	.125"	1.5 or 1.67"	49-352SQ/L/1H
2"	.125"	2"	49-352SQ/L/2

Square Adjustable Handrail Saddle, Flat



Connects a square post to a flat top rail. Adjustable saddle is for stair applications.

SQ. TUBE DIAMETER	TUBE THICKNESS	TOP RAIL	PART NUMBER
1.5"	.125"	Flat	49-352ASQF/1H
2"	.125"	Flat	49-352ASQF/2

Square Fixed Handrail Saddle, Flat



Connects a square post to a flat top rail. Adjustable saddle is for stair applications.

SQ. TUBE DIAMETER	TUBE THICKNESS	TOP RAIL	PART NUMBER
1.5"	.125"	Flat	49-352SQF/1H
2"	.125"	Flat	49-352SQF/2

Square Handrail Corner Saddle, Flat



Square post corner connection for two mitered flat top rails.

SQ. TUBE DIAMETER	TUBE THICKNESS	TOP RAIL	PART NUMBER
1.5"	.125"	Flat	49-352SQF/L/1H
2"	.125"	Flat	49-352SQF/L/2

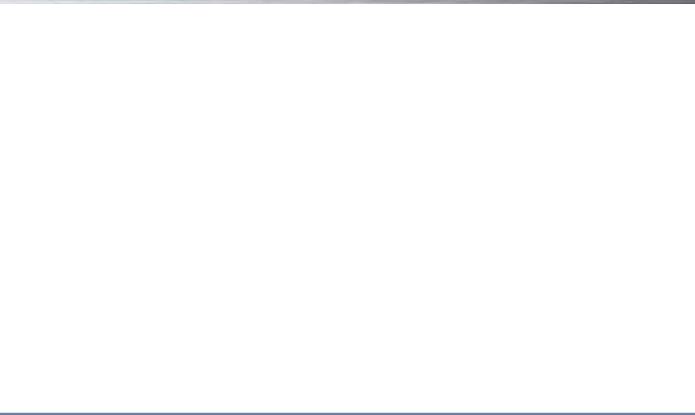

Wall-mount Handrail Saddle, 1.67"



This saddle offers a wall-mounted application for hand railing, no posts necessary.

SQ. TUBE DIAMETER	TOP RAIL	PART NUMBER
N/A	1.5" or 1.67"	49-309/1H
	Flat	49-309/F

Post-mount Handrail Saddle for Square Posts



This saddle mounts to square posts to create a double handrail. Supports a 1.5" round top rail.

SQ. TUBE DIAMETER	TUBE THICKNESS	TOP RAIL	PART NUMBER
N/A	N/A	1.5" or 1.67"	49-309PF/1H
		Flat	49-309PF/F

Handrail Saddle for Glass, Flat



This saddle mounts to glass or plexi. Flat saddle accommodates square tubing.

SQ. TUBE DIAMETER	PANEL THICKNESS	TOP RAIL	PART NUMBER
N/A	3/8" to 1/2"	Flat	49-308GMF

Glass-Spiders for Square Posts



Spiders secure glass to flat posts. Combined with our 2-inch tubing, it is extremely durable.

POSITION	ACCOMMODATES GLASS THICKNESS	PART NUMBER
End	1/2" or 3/4"	49-876E/F/3
Center	1/2" or 3/4"	49-876C/F/3

Glass Grips



Glass Grips for both round and flat tubing secure glass or plexi between posts.

POST-MOUNT DIAMETER	ACCOMMODATES GLASS THICKNESS	PART NUMBER	SIZE
Flat	1/4" or 3/8"	49-850F	Small
1.5" or 1.67"	1/4" or 3/8"	49-850S/1H	Small
Flat	3/8" or 1/2"	49-860F	Large
1.67"	3/8" or 1/2"	49-860S/424	Large

Rubber Inserts

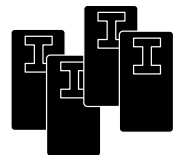

ITEM #	USE WITH	GLASS THICKNESS
85-GGI1003	Small Grips	1/4"
85-GGI1004	Small Grips	3/8"
85-GGI1005	Large Grips	3/8"
85-GGI1006	Large Grips	1/2"

RAILING COMPONENTS

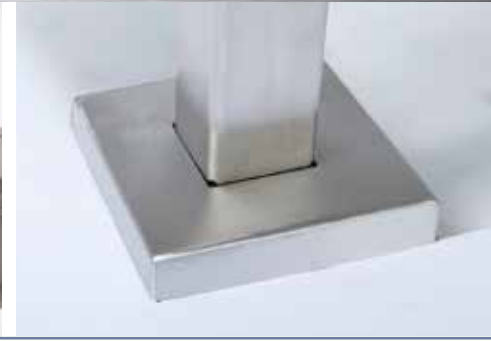

Square Flange



Mount prefabricated posts to flooring.

SQ. TUBE DIAMETER	FLANGE THICKNESS	PART NUMBER
1.5"	0.315"	49-593/1H
2"	0.315"	49-593/2

Square Flange Canopy



Cover a flange's hardware with a satin-finished canopy.

SQ. TUBE DIAMETER	THICKNESS	PART NUMBER
1.5"	.06"	49-540SQ/1H
2"	.06"	49-540SQ/2

Fascia Mount for Square Posts



Mount prefabricated posts to a wall. Available for both 1.5" and 2" square tubing.

SQ. TUBE DIAMETER	TUBE THICKNESS	PART NUMBER
1.5"	0.125"	WA106/1HSQ
2"	0.125"	WA106/2

Square End Cap



A clean, flush look caps the top of a square post or the end of a top rail.

SQ. TUBE DIAMETER	TUBE THICKNESS	PART NUMBER
1.5"	.125"	49-650/1H11

Pressfit Square End Cap



Product description.

SQ. TUBE DIAMETER	TUBE THICKNESS	PART NUMBER
1.5"	0.06"	49-650/1H
2"	.125"	49-650/211

Square Adjustable Elbow



A clean, flush-look adjustable elbow connects square tubing at almost any angle.

SQ. TUBE DIAMETER	TUBE THICKNESS	PART NUMBER
1.5"	0.06"	49-732ASQ-06/1H

Square Flush Ell



Create a clean, flush 90° angle connection with square tubing.

SQ. TUBE DIAMETER	TUBE THICKNESS	PART NUMBER
1.5"	0.06"	49-732SQ-06/1H

Square Splice



Connects two pieces of square tubing to make a continuous linear railing.

SQ. TUBE DIAMETER	TUBE THICKNESS	PART NUMBER
1.5"	0.06"	49-830SQ-06/1H

TUBING

The tubing for top rail is one of the biggest considerations of any railing project. We stock tubing in multiple sizes, finishes and wall thicknesses. Our tubing is generally offered in 12', 16' and 20' lengths, however cutting services are available at either of our plants to customize lengths.

Tubing for Top Rail

PART	DESCRIPTION	TUBE DIA.	WALL THICK	FINISH
49-A111	1.5" Round Tubing, 20-ft. length	1.5"	.06"	Satin
49-A113	1.5" Round Tubing, 20-ft. length	1.5"	.125"	Satin
49-A114	1.67" Round Tubing, 20-ft. length	1.67"	.08"	Satin
49-A121	2" Round Tubing, 20-ft. length	2"	.06"	Satin
49-C12122	1.5" Square Tubing, 20-ft. length	1.5"	.06"	Satin
49-C12124	1.5" Square Tubing, 20-ft. length	1.5"	.12"	Satin
49-C16164	2" Square Tubing, 20-ft. length	2"	.12"	Satin
49-C20205	2.5" Square Tubing, 20-ft. length	2.5"	.25"	Satin
47-A111	1.5" Round Tubing, 12 or 20-ft. lengths	1.5"	.06"	Polished
47-A114	1.67" Round Tubing, 20-ft. length	1.67"	.08"	Polished
47-A121	2" Round Tubing, 20-ft. length	2"	.06"	Polished
47-C12122	1.5" Square Tubing, 20-ft. length	1.5"	.06"	Polished



Generally available in 12-, 16- and 20-ft. standard lengths. Cutting services available. Also available in mill lengths.

ACCESSORIES

Keep your 316 stainless steel architectural railing systems looking their best with Railing Care products.

Adhesive, Primer, Cleaning and Polishing

PART	PRODUCT	DESCRIPTION
00202	Metal Polish	Polish
00201	Loctite 326	Adhesive
00211	Loctite 7649	Primer
00203	MAAS Stainless Steel Cleaner	Cleaner
00204	MAAS Polishing Cloth	Cloth

