

SSX-51/SSX-51S ARMORED SIREN/SIREN STROBE



Patented

- Indoor/outdoor 15 watt armored siren
- 122dB sound output
- Warble sound output
- Rust-free aluminum die-cast
- Polarized 12VDC input with reverse polarity protection
- Dual-action reed tamper switch
- Up-front screw terminals for easier field wiring
- Suitable with use for most control panels
- Mounts directly to the wall or to 4" square back box
- 60,000 candle power strobe
- Available strobe lens colors: amber, blue, clear, red

The SSX-51 is a patented indoor/outdoor, self-contained, 15 watt, armored siren. The full featured siren consists of a single tone that delivers a warble sound output, light weight, rust-proof aluminum die-cast housing, a 122 dB output siren driver, and a dual action normally open reed plunger switch for normally closed loop. The armored siren does not require additional modules, metal boxes, tamper switches, special tools, or training to install and operate. The SSX-51 series comes completely assembled and ready for installation.

The SSX-51S Siren Strobe combination is also available. It is a high quality, high output siren with a 60,000 candle power strobe with available lens colors: amber, blue, clear, and red.

The SSX-51 series is ideally suited for noisy, heavy machinery areas, warehouses, loading docks, print shops, busy production floors, or for indoor/outdoor applications where high quality and high output warning is required.

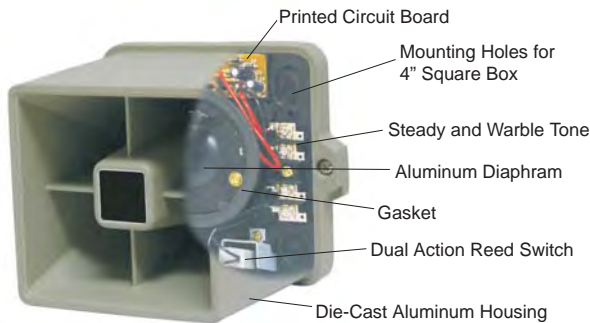

Model Number	Input Voltage	Current Draw	Operating Voltage Range	Strobe Specifications			Speaker Specifications		Operating Temperature Range
				Lens Color	Strobe Candle Power	Flash Rate	Sound Output	Tamper Contact Capacity	
SSX-51	6 -12V DC	.56 Amps	4.8 - 14.4 V DC	-	-	-	122dBA	0.3A @ 12V DC	14°F - 140°F -10°C - 60°C
SSX-51SA	12V DC	0.67 Amps	9.6 - 14.4V DC	Amber	60,000	20 - 100 times/min.			
SSX-51SB				Blue					
SSX-51SC				Clear					
SSX-51SR				Red					

SSX-51/SSX-51S ARMORED SIREN/SIREN STROBE

Dimensions: inches (mm)

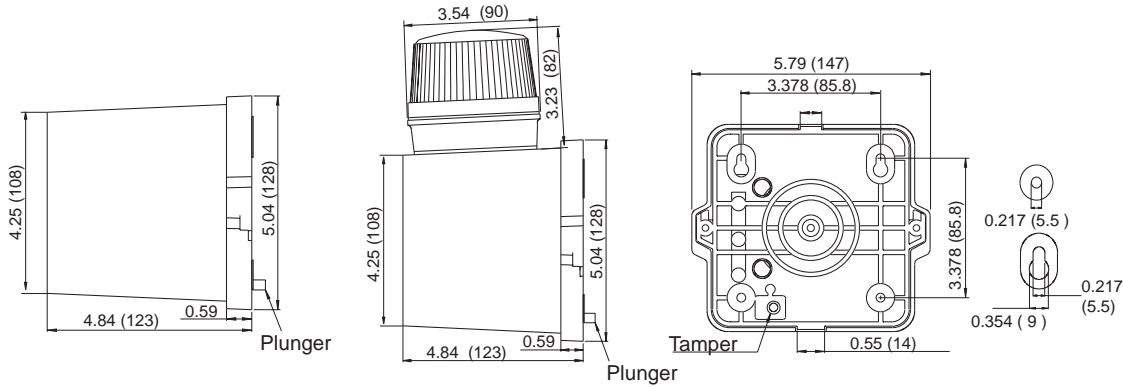

Installation

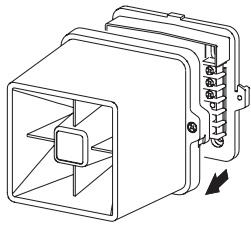

Step 1
Separate the housing from the back plate.

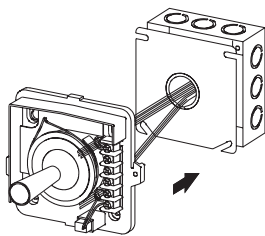

Step 2
Mount the back plate directly to the wall or to a 4" square box.

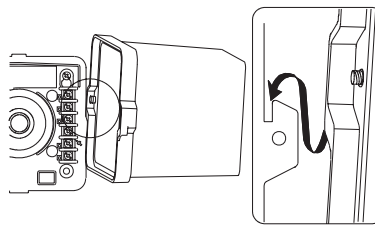

Step 3
Place the housing over the built-in hook to free your hands during wiring.

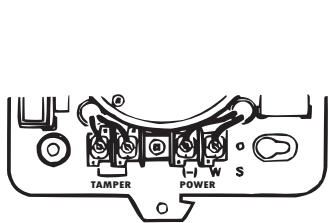

Step 4
Connect the siren wires to the terminal strip as indicated above, and re-install the cast iron housing.

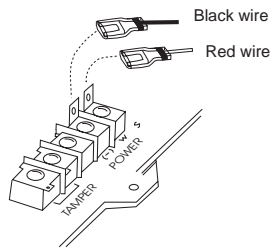

For SSX-51S
Connect the Red wire from the strobe to the (w) terminal and the Black wire to the (-) terminal on the back plate as indicated.

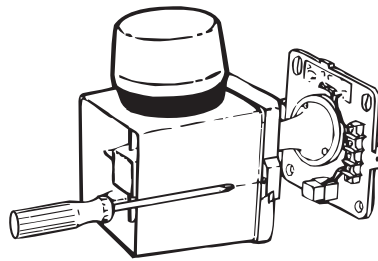

Step 5
Re-install the cast iron housing, making sure it aligns properly with the back plate before securing the screws.